

Product Encyclopedia & Safety Manual



Complete Safety and Use Information
For Ceramic Products and Art Materials
In The Classroom and Studio



AMACO[®]
American Art
Clay Co., Inc.
Indianapolis,
Indiana 46222

www.amaco.com



brent[®]
potter's wheels
and equipment

- Kiln Firing Guidelines
- Complete AMACO[®] Glaze Color Chart
- Contemporary Studio Information

GENESIS[™]
ARTIST COLORS
HEAT-SET ARTIST OILS



NON-TOXIC

Certifying symbols of the Art and Creative Materials Institute (ACMI)

All AMACO[®] Product Labels Conform To ASTM D-4236



www.genesisartistcolors.com

www.brentwheels.com

www.genesisdecorativeart.com

IMPORTANT

The information contained in this booklet is accurate to the best of our knowledge at the time of printing and is subject to change as new data becomes available. The information contained herein does not apply to industrial usage of our products and inquiries about safe use in production situations should be made on an individual basis.

Since there is a low incidence of health injuries associated with ceramic programs (and for the most part these injuries are caused by product misuse), we feel that by using this book as a guide, artists, hobbyists and students can enjoy a safe, rewarding and healthful ceramic program.

In an article published in the North Carolina Medical Journal, ACMI's toxicologist, Woodhall Stopford, M.D. and Director of the Occupational Medicine Education Program at Duke University, recommends that glazes containing lead be used only by individuals who are capable of following safety guidelines and if supervision is required, lead-free non-toxic glazes should be used (Reprints of Dr. Stopford's article are available upon request from AMACO®).

AMACO® recommends that nursing homes, hospitals, and institutions use **ONLY** products bearing the AP non-toxic seal to ensure the highest standard of safety in any ceramic program requiring supervision (See Appendix IV, page 42). **Consumer Product Safety Commission (CPSC) regulations, LHMA, and FHSA require the use of ONLY non-toxic (AP) evaluated products in grades pre-K through 6. Likewise, for students in grades 6-12, products must have been evaluated under ASTM D-4236 procedures and properly labeled (CL) when cautions are required.**

As a teacher or purchaser for schools, the law permits the CPSC to sue to enjoin the purchase of any art or craft material with chronic or acute hazard warning label for use in pre-kindergarten through grade 6. It may amount to professional malpractice for a teacher or school to ignore these requirements, aside from any civil or other liability concerns. Although the law does not address this point, if an elementary school teacher purchases such a product for his or her own use on student artwork, the teacher should use the product only after classes are over, should follow safe instructions on the label, and should store the product outside the classroom. AMACO® also believes that these same restrictions must be applied in nursing homes or in institutions where people with diminished mental capacities are doing ceramics. People in such environments do not have the ability to protect themselves from exposure if they are not using non-toxic glazes.

Another area of concern are the home and home-studio. Small children are exposed to chemicals through the use of the product or through contamination by eating and drinking that occurs in both environments.

Owners of contemporary studios who make eating and drinking a part of the ceramic experience run a higher risk of exposure, therefore, only (AP) non-toxic glazes should be used in these environments. Studio owners should do the glazing by dipping to reduce chemical exposure to the inexperienced customer. This practice should be done in a separate room, away from the customers. Rules on housekeeping, personal hygiene, and the use of personal protective equipment must be strictly enforced in such environments. See the section, "Contemporary Ceramic Studio Safety Guidelines", page 7, for more information.

TABLE OF CONTENTS

Introduction	3	Loading and Firing the Kiln	15
Safe Use of Ceramic Art Materials	4	Kiln Vents	16
Housekeeping.....	4	Ceramic Specialty Products	17
Personal Hygiene	4	Non-Ceramic Art and Craft Materials	17
Personal Protective Equipment.....	4	How To Use AMACO® Products	18
Clays and Slips	4	General Glaze Application Methods	18
Using Clay and Slip Safely	5	AMACO® Glazes and Underglazes	19
Aging of Clay.....	6	AMACO® Ceramic Specialty Products.....	28
Glazes	6	Genesis® Artist Colors	30
Contemporary Ceramic Studio Safety Guidelines	7	AMACO® Art and Craft Products.....	31
Firing Safety	7	Trouble Shooting Guide — AMACO® Glazes and Underglazes.....	39
Glaze Labeling	8	Appendix I — The Art & Creative Materials Institute, Inc.	41
Underglaze Labeling.....	11	Appendix II — American Society for Testing and Materials (ASTM) ..	42
Specialty Underglaze Labeling.....	12	Appendix III — Major Health Hazards	42
Overglaze Labeling.....	12	Appendix IV — Federal Labeling Law of Art Materials	42
Aerosol Sprays and Solvents	13	Appendix V — Quick Reference List of all AMACO®	
Spraying and Airbrushing	13	Glazes and Underglazes.....	43
Kiln Firing Guidelines	14	Conclusion	44

Published by

American Art Clay Co., Inc.

4717 W. Sixteenth Street, Indianapolis, Indiana 46222

(317) 244-6871 • (800) 374-1600 • Telefax (317) 248-9300

This booklet is also available on the AMACO® WEB page, www.amaco.com.

Eighth Printing

11979R 15M0903

INTRODUCTION

Your concern for a quality ceramic program and for health and safety information is very important to us. Experts in art and education stress that three-dimensional clay activities are crucial to the proper development of a child's small motor skills and creative potential. Everyone should know that a safe and healthful ceramic program **IS** available.

To help you, we have voluntarily submitted all of our formulas for independent toxicological evaluation within The Art & Creative Materials Institute, Inc. (See Appendix I, p. 41). AMACO® clay boxes and AMACO® glaze labels clearly state which products are non-toxic and dinnerware safe and identify precautions and appropriate warnings. All AMACO® products display the AP, or CL Certification seals which attest this toxicological evaluation and certification. This certification includes conformance to the American Society for Testing and Materials ASTM D-4236 Chronic Hazard Labeling Standard (See Appendix II, p. 42).

80% of all AMACO® glazes and 97% of all AMACO® underglazes are certified non-toxic and as such are authorized by The Art & Creative Materials Institute, Inc. to carry the AP Approved Products Non-Toxic seal. In addition, 95% of AMACO® glazes and underglazes are LEAD FREE. Glazes that carry the "AP" Seal and are packaged in dry form must be mixed in the same plastic jar they are in. Do not pour the dry powder in another container to mix. Follow mixing instructions that are on the label. Some of the glazes may contain crys-



talline silica and dust producing procedures **MUST** be avoided. Moist clays have the AP Non-Toxic seal but dry clays display the CL Cautionary Label with dust warnings because of the presence of fine silica sand. In the moist form, which is the form in which 95% of our clay is produced, there is no hazard. The safety warning is there to alert users of the need to use masks if dust is produced in reclaiming or mixing. Keep clay moist during the modeling process.

This booklet has been prepared to help answer questions about safety in the art room and ceramic studio. With the information presented here along with good common sense and a total AMACO® program, ceramics can continue to be safe for young children as well as adults. Knowledge of the products being

used is the first measure in instituting a safe art program. This booklet will give you the information you need to **KNOW** about the ceramic materials you are choosing.

AMACO® has submitted all of its formulas to the Art and Creative Materials Institute, Inc. Certified Products Bureau for evaluation by the Institute toxicologist for chronic and acute health hazards. AMACO® products are properly labeled in compliance with ASTM D-4236 and bear the Institute's AP seal (Approved Product, Non-Toxic) or CL Cautionary Labeling (proper labeling of ingredients for health and safety). Material Safety Data Sheets are available for all AMACO® products and can be referred to whenever there is a question on the safe use of a product. Most information you

need from the Material Safety Data Sheets is on the label itself.

We recommend that teachers, studio owners, and nursing home administrators keep this booklet on hand as a constant reference in the classroom or studio and when ordering. This booklet is provided **FREE** of charge for anyone who wants to use ceramic and art materials safely. We urge you to share a copy with school administrators, craft people, hobbyists, and parents so that everyone concerned will understand that with proper equipment, supplies, and housekeeping, ceramics is just as safe as it is rewarding.

SAFE USE OF CERAMIC ART MATERIALS

HOUSEKEEPING

If a few simple, common sense housekeeping rules are followed, a ceramic studio, classroom or workplace can be clean and healthful, free of dust and mist.

- ◆ Be sure that the work area is well ventilated.
- ◆ Work surfaces and shelves should be kept clean by wiping them down with a wet sponge that is rinsed frequently.
- ◆ Always mop floors. If impractical to mop, use a dust vacuum with dust filters 99.995% effective at 0.33 microns, or use a combination of either a commercial sweeping compound or a water mist coupled with an appropriate dust mask or respirator. Perform clean up operations at the end of the work session to allow any escaping dust to settle out of the air before the next work session.
- ◆ Clean up spills as soon as they occur.
- ◆ Work on newspaper or paper towels for easy clean up.
- ◆ Clean glaze jar rims before closing to eliminate build up of dried product.
- ◆ Brushes should be washed immediately after use.
- ◆ To prevent dust when mixing small quantities of AMACO® dry clay or Egyptian Paste, add water to dry powder in a plastic bag, affix twist tie and wedge the clay in the bag.
- ◆ To prevent dust, discard scrap clay in a plastic bag before it dries.
- ◆ Do all spraying or airbrushing in a spray booth equipped with an outside vented exhaust fan.
- ◆ Always keep dust under control.
- ◆ Work over a linoleum or sealed floor. All work surfaces should be non-porous. These measures allow easy clean-up of spills and dust and prevent tracking.

PERSONAL HYGIENE

Again, common sense should be the watchword when working in ceramics.

- ◆ Ceramic products should not be ingested or inhaled.
- ◆ Eating, drinking and smoking should **NOT** be combined with working on ceramics.
- ◆ Any cuts or open wounds should be protected from foreign materials.
- ◆ Always wash hands and arms thoroughly when through and before leaving the work area, even after removing gloves.
- ◆ Never use any utensils for ceramics that will later be used in the kitchen.
- ◆ If there is an accidental ingestion and you are concerned, call a doctor or your local Poison Control Center. All AMACO® products are listed with the National Poison Control Network.

PERSONAL PROTECTIVE EQUIPMENT

Simple Protective equipment is recommended for **SOME** areas of ceramics.

- ◆ Kiln gloves should be worn when handling a hot kiln. **ONLY A QUALIFIED ADULT SHOULD EVER TOUCH OR OPERATE A KILN.** Never touch the outside of a kiln (other than the control panel) without gloves after it has been turned on as the entire outside surface will be extremely hot.
- ◆ Dark-shaded glasses from a safety supply house (shade number 1.7-

3.0) are recommended for looking into kiln peepholes. Normal sunglasses are inadequate for this use. Dark glasses protect the eyes from radiating heat and allow you to watch the sight cones more clearly.

- ◆ An apron or smock which can be left in the work area is recommended. This protects one's clothing and keeps the dust from leaving the studio. Regular laundering is suggested. A cover-up is helpful when working with elementary age students. When laundering work garments, wash them separately from other clothes.
- ◆ NIOSH-approved dust masks and a locally exhausting spray booth should be used when spraying glazes containing silica. **Lead-containing glazes should NOT be spray applied in classrooms or studios. Suitable lead-free AMACO® glazes for this purpose are available.**
- ◆ Remove jewelry and use vinyl or lined rubber work gloves and an impermeable apron, when glaze dipping or when loading the kiln with products finished with leaded glazes.
- ◆ If pregnant or considering pregnancy **DO NOT** use lead containing glazes.
- ◆ Lead containing glazes **MUST BE** kept away from children K-6.
- ◆ It is extremely important that dusts from ceramic studios not be tracked into environment where children may play.



CLAYS AND SLIPS

AMACO® was the first clay manufacturer in 1984 to have all of its clay bodies approved by the Art and Creative Materials Certified Product Bureau for Health Labeling Certification. All AMACO® clays are Non-Toxic when moist; in dry form clays require a dust warning because they contain silica. To avoid dust problems, it is recommended that only moist clay bodies be used in schools. AMACO® prepared moist ceramic clays are de-aired and quality controlled for mixture, plasticity and uniformity. "...Ready mixed clay is preferable because it eliminates the need for dust-handling or mixing equipment." (Qualley, *SAFETY IN THE ARTROOM*, p. 77)

The following clays bear the AP Approved Product Seal of the Institute certifying these clays to be **NON-TOXIC** when moist.

- AMACO® Clay No. 27 White Sculpture Clay
- AMACO® Clay No. 46 Buff Firing Stoneware Clay
- AMACO® Clay No. 20 Versa Clay
- AMACO® Clay No. 67 Indian Red Clay

AMACO® Clay No. 25 White Art Clay
 AMACO® Clay No. 77 Terra Cotta Clay
 AMACO® Clay No. 38 White Stoneware
 AMACO® Clay No. 48 Stoneware Body with Grog
 AMACO® Clay No. 480 Stoneware Body without Grog
 AMACO® Clay No. 58 Warm Brown Stoneware Clay
 AMACO® Clay No. 65 Porcelain Clay
 AMACO® Moist Clay No. X-11, X-15, X-12
 AMACO® Clay Flour No. X-23, X-26A
 AMACO® Clay No. 15-S White Earthenware Slip

They present **NO** health hazard when moist. Just use these clays properly. Good housekeeping and personal hygiene must be practiced. Follow directions under “Using Clay and Slip Safely”, pages 5 and 6.

The following clays and products bear the CL Cautionary Label Conformance Statement. They present **NO** health hazard when moist. The following clays and products can be used safely as long as they are used properly and again, good housekeeping and personal hygiene are being practiced.

AMACO® Dry Clay No. 25 White Art Clay
 AMACO® Dry Clay No. 67 Red Clay
 AMACO® Dry Clay No. 46 Buff Clay
 AMACO® Dry Clay No. 48 Stoneware Body with Grog
 AMACO® Slips—No. 1 Porcelain, No. 67-S Indian Red, DS-225 White
 AMACO® Egyptian Paste—All Colors

If you choose to store and mix dry clay, be sure to follow all the housekeeping and hygiene rules already stated. In addition the following precautions should be taken as stated by Charles Qualley in his book, *SAFETY IN THE ARTROOM*, p. 77:

- ◆ *Store and mix clay in an area separated from the studio so as to reduce the area of dust contamination.*
- ◆ *Keep all powdered clay bags in storage covered tightly with polyethylene sheeting to contain the dust.*
- ◆ *Stack clay bags off the floor on pallets or shelves so that cleaning the floor is easier and more complete.*
- ◆ *Wear a dust mask specifically designed to filter out silica and other particles whenever working in the clay mixing room or when sanding a dry, but unfired (greenware) object. Be sure the mask is the correct type (one having NIOSH approval #TC-21C-132, for example).*
- ◆ *Have a local exhaust system operating whenever the clay mixer is in use; this will draw off most, though not all, the problem particles.*

Slips can be purchased as a liquid or dry powder, but most are available in liquid only. Again, for classroom use, liquid is preferred, but if dry slip is purchased, the same guidelines as used for mixing dry clay apply.

USING CLAY AND SLIP SAFELY

Silica, which occurs naturally in all ceramic clay products, including slip, has been linked to possible environmental health problems. Long term exposure to silica may cause lung damage. Silica is considered a cancer agent by inhalation based on experimental data (Prop. 65, California Health and Safety Code Section 25249.6ET.SEQ.), requires clay packages containing silica to state: Detectable amounts of chemicals known to the State of California to cause birth defects or other reproductive harm may be found in this product. These health problems may occur through long-term respiratory exposure to dust from the dry clay or dry slip mix.

Clay in the moist or slip form is considered **NON-TOXIC**. Always keep in mind to finish the work while the clay is still wet. Finish with a wet

sponge; do not sand.

In order to use clay safely, dust producing procedures (dry mixing, sanding) should be avoided whenever mixing or working with clays. This can be done very efficiently in either a small or large studio operation.

It is practically impossible to make slip from dry clay without producing dust. For this reason, premixed slip is not only safer but also well blended and quality controlled. Such a slip is ready-to-use; just shake or stir and pour into the mold.

If you have to mix slip from dry powder, make sure that the mixing tank is in a well ventilated area equipped with a mechanical air ventilation system. When dumping powder, use only a NIOSH approved particulate respirator for dust and replace it often. If the face side of the respirator gets dirty or contaminated, replace it immediately. A safety supply house is the best source of suitable equipment. For more detailed information about masks for protection against dust contact: Dept. of Health & Human Services, National Institute For Occupational Safety & Health (NIOSH), Mail Stop C-19, 4676 Columbia Parkway, Cincinnati, OH 45226, (800) 356-4674, (513) 533-8328 (Outside U.S.).

To produce moist clay, do not mix large quantities from dry powder. You will find it very hard not to produce dust. Commercial moist clay which is well blended and de-aired is safer and more economical in the long run. Such a clay is ready to use. Just wedge and throw on the wheel or hand model. If only small quantities of clay have to be mixed from dry powder, this may be achieved fairly easily. Put the dry powder (clay) carefully in a plastic bag, add water as needed and tie seal the bag. Wedge the clay while it is inside the bag. Once all the dry materials are mixed, the clay may be taken out and wedged on a plaster bat or added to a pugmill if one is available.

It is best to trim cast greenware before it dries hard. Use a fettling knife and cut off the excess trim and seam line; then, with a soft wet sponge, wipe smooth.

When you have to trim dry greenware, first spray the area that needs trimming with water. Do not soak it at one time. Spray lightly, let the water be absorbed into the clay, then spray again until it becomes fairly wet. When the clay is wet enough, cut away the trimmings and smooth out with a wet sponge.

If working extensively on a piece like engraving a low relief design, try to keep it wet as long as your work is in progress by spraying it with water every so often or just keeping it covered with a plastic bag during work breaks.

Slip trailing is an alternate, safer way for producing low relief designs. Take some slip in a jar or small container and add a dash of plaster (or any other thickener). When the slip becomes thicker, fill a slip trailer bottle and use it to apply your low relief design on the piece.

Trimmings from cast pots or engravings can be reconstituted in a safe way by avoiding drying them out. Collect them in a pail as they are produced then cover with water. These trimmings could be added to new slip mix, with a minor adjustment to viscosity.

When working in a small pottery operation, the easiest way to save the trimmings is to put them into a plastic bag (the same bag the clay came in) and depending on the dryness of the trimmings, a little water may be sprinkled into the bag and wedged while in the bag. Let this clay sit sealed



for a week or two, then it is usually ready for use. Take it out of the plastic bag and wedge thoroughly. If it is too wet, wedge in some fresh clay until a good throwing consistency is achieved. It is then ready to use again.

Of course, if a pugmill is available, just add the trimmings into the pugmill adding fresh clay as needed.

Although different ways are used to salvage the trimmings, they all lead to the same purpose, which is safely using all the purchased clay and not generating any waste.

Any waste should be disposed of in accordance with Federal, State and Local regulations. The above information references ASTM C1191, "Standard Guide for Using and Handling Clays and Slips Safely."

AGING OF CLAY

Aging of clay is a very important step in improving workability and plasticity of clay bodies because it takes time for water to penetrate between the clay particles and produce a good and permanent bond.

Bacterial growth also has a definite effect on improving plasticity of the clay. It is suggested that some old clay should be left in the container where new clay is added to accelerate bacterial growth in the clay.

The great Chinese potters have for centuries aged their clay in underground pits. It is said that potters would mix clay bodies for their children to use while they would use clay aged for them by their fathers.

In our fast paced modern world, AMACO® manufactured clay may vary in age, but bacterial gels (mold) will be noticed sometimes in a marbled pattern on the clay. Such clay has a very good feel to it when wedging, which should be done to achieve maximum plasticity and uniformity.

GLAZES

Glazes have been the center of much of the controversy over health hazards and how they pertain to ceramic programs. As a major manufacturer of many types of glazes we believe that by offering our customers complete information on all of our glazes, they will be qualified to choose the glaze appropriate to their needs. Since we manufacture glazes used by professional potters, hobbyists and college ceramic studios, as well as elementary and secondary school art programs, we need to offer a wide range of types and colors to satisfy many individual requirements. All AMACO® glazes and underglazes are manufactured as **BRUSH ON** glazes. They contain wetting agents for improved brushability and leveling in application.

There are two types of health information on the labels and in the catalog for AMACO® glazes to consider in regard to health when choosing a glaze. One is concerned with the pre-fired glaze (liquid or dry powder) and is indicated by the AP or CL seals. This information conforms to ASTM D-4236.

The second consideration is the lead release information on the glaze after it is fired (Is this glaze safe for food and drink containers?). In November, 1991, the Food and Drug Administration reduced its informal guidelines levels for lead leaching from ceramicware and put them into effect. These levels were reduced by appreciable amounts. The new FDA guidelines are as follows:

- 3 PPM for plates, saucers and other flatware
- 2 PPM for small holloware, such as cereal bowls, but not cups and mugs
- 1 PPM for large (greater than 1.1 liters) holloware such as bowls, but not pitchers
- 0.5 PPM for pitchers
- 0.5 PPM for cups and mugs

Proper firing of dinnerware glazes is critical. Use pyrometric cones on the kiln shelves to ensure that the pieces are fired to the recommended temperature even if the kiln is electronically controlled or has an automatic kiln sitter. Always fire in accordance



with the label instructions. Due to the many variables that can affect lead leachability in finished ware (exact firing temperature, contamination from other ware being fired in the kiln, etc.), AMACO® recommends that the producer of any for sale dinnerware have it tested for leachable lead by an approved laboratory to determine whether or not it meets FDA guidelines in its own category **BEFORE IT IS PUT ON THE MARKET.** AMACO® glazes reflect the current standard as glazes are produced.

In regard to lead release or dinnerware safety (Will lead leach out of the finished pottery after it is properly fired?), our glazes fall into five categories:

1. "Lead Free" which means that the glaze contains no lead or cadmium bearing ingredients and is safe for all uses **IF PROPERLY APPLIED AND FIRED TO THE CORRECT TEMPERATURE.**
2. "Lead Safe" which means that the glaze contains some lead and/or cadmium compounds but passes tests for lead and cadmium release making it safe for all uses **IF PROPERLY APPLIED AND FIRED TO THE CORRECT TEMPERATURE.** Do not intermix different food-safe glazes, as the balance of ingredients in each glaze will be disrupted. Each mixture would have to be retested by an approved laboratory to determine if the mixture is also food-safe.
3. Contains some lead and/or cadmium compounds and does **NOT** pass test for lead and cadmium release. Not recommended for surfaces which come in contact with food or drink.
4. Contains no lead or cadmium bearing ingredients. We do not recommend these glazes on surfaces which come in contact with food or drink due to the soft or crackle nature of the glaze, even though they pass tests for lead and cadmium release.
5. Contains no lead or cadmium bearing ingredients but does not pass tests for lead and cadmium release due to the soft crackle nature of the glaze. Not recommended for surfaces which come in contact with food or drink.

The AMACO® catalog and individual glaze labels explain the above information for each glaze.

Conforming to the chronic health labeling standard ASTM D-4236, AMACO® has labeled each of its glazes for safety showing whether or not a glaze (unfired) is totally non-toxic and, if not, what precautions should be taken for safe use during application. There are four types of AMACO® labels (A, E, EE, and F) and each is shown as an example introducing those glazes that fall in each group. Material Safety Data Sheets are also available for all AMACO® glazes. We hope that the information on **ALL** AMACO® glazes starting on page 8 will confirm that with proper use, AMACO® ceramic glazes are safe for the classroom and the studio. However, the most important step that should be taken is to read the label with care. In ceramics, as in all areas of human activity, proper use of products ensures safety. Misuse of products may expose the ceramist to potentially harmful substances.

All glaze numbers marked with a fork and knife (®) **ARE DINNERWARE SAFE.** (See Appendix V, page 43).

CONTEMPORARY CERAMIC STUDIO SAFETY GUIDELINES

Contemporary Studios have been established to provide a service in a relaxed recreational environment where customers would decorate prefired bisqueware with underglazes or stains. The pieces are then covered with a dipping glaze and fired.

Food, drinks, and children play areas are also available at these facilities, which brings to concern the use of toxic material in these activities.

Contemporary studio operators **MUST** and **CAN** establish a safe and healthful business by using **ONLY LEAD FREE** underglazes and glazes which are available.

AMACO's Gloss Decorating Colors (GDC) are a series of lead free **BISQUE UNDER-GLAZE** that are excellent for application on bisque in whatever manner. Customers do not have to be experts to use them. They can be applied thick or thin without any problem. AMACO® DC-10, a superb, clear, **LEAD FREE** dipping glaze, is also available upon request, in addition to the large selection of AMACO® lead free LUG underglazes, Velvets, and lead free glaze series.

Maintaining completely lead free products in the studio is the only way to have a successful and safe business.

To insure safety in the studio refer to the "Safe Use of Ceramic Art Materials" on page 4 — Sections: "Housekeeping", "Personal Hygiene", and "Personal Protective Equipment".

Studio attendants, as well as the clientele, include women of child bearing age and children. These segments of the population are at greatest risk from lead in glazes if used in these environments.

The availability of food and drink while decorating ceramics at these studios is also of great concern. It is recommended that food and play areas be away from the working areas. It is vital that everyone understand the health risks of lead contamination which may lead to lead poisoning, that can occur through hand contamination and eventual hand to mouth exposure. Exposure may also occur from airborne dust in a dusty studio. Children, pregnant women, and individuals with calcium or iron deficiency, absorb lead more readily. Children, infants, and the developing fetus are most sensitive to brain damage from lead exposure. Brain effects may manifest themselves as changes in behavior or poor school performance. Other lead related effects include damage to the peripheral nerves with weakness, abdominal pain, anemia, and kidney damage. Lead can cause sterility in men and is an experimental kidney cancer agent. Early effects of lead poisoning are subtle: there are no early warning signs.

Production of bisqueware and firing is best done at another facility. When finishing greenware, always finish while in the leather-hard state. Do not sand. Do not produce dust. Damp mop after each work session.



Clay dust contains quartz. Excessive inhalation of quartz dust can result in chronic lung damage. If dust is present, use an OSHA approved mask for dust and mist. See "Using Clay and Slip Safely," page 5.

Greenware firing can release large amounts of carbon monoxide and may release sulfur dioxide. Carbon monoxide prevents blood from carrying oxygen. The fetus is most sensitive to carbon monoxide poisoning: excessive exposure to carbon monoxide can result in brain damage. Adults with coronary artery disease can get angina when exposed to carbon monoxide. Sulfur dioxide can result in airway inflammation. Individuals with asthma are particularly sensitive.

Acute exposure to fluorides which may be released during firing, can result in mucous membrane and airway irritation. Chronic exposure can result in damage to the kidney and bones.

FIRING SAFETY

1. Kilns must be placed in a separate room, not in the working area.
2. Always use a down draft kiln vent or other venting system connected to the outside.
3. Customers should not be allowed access to the kiln room when kilns are operating. See pages 13-15 on firing and kiln vents.

Employees should be knowledgeable about both hazards and safety procedures. They should abide by and enforce them. Employees should also be supplied with the necessary safety equipment. Post safety rules in the studio and work area for both customers and employees to see.

GLAZES

LABEL A

AP NON-TOXIC: These glazes are safe for use as either a dry powder (need to be mixed with water) or as a liquid and can also be sprayed safely. However, always wear a NIOSH approved mask for dust and mist if spraying. Individual labels or the catalog should be checked to see if a glaze is appropriate for food and drink containers. An AMACO® package label is shown as an example.



AMACO Liquid Gloss Glazes
LG Series



NON-TOXIC



LG-10
Dinnerware safe when applied and fired to the recommended temperature on label.
LEADFREE

CLEAR TRANSPARENT
1 GAL. (3.78L)

DIRECTIONS: Shake and stir well before using. Thin with water if needed or to improve brushability, add AMACO® Gum Solution. Apply 3 brush coats to properly matured Cone 04 bisque. Fire to witness Cone 05. This glaze may also be applied by sponging, dipping or pouring.

Request Material Safety Data Sheets when using in manufacturing. Tableware producers must test all finished ware to establish dinnerware status, due to possible variations in firing temperature and contamination.



Reorder# 39173W
0 39672 59173 4
LG-01

American Art Clay Co., Inc.
Indianapolis, Indiana 46222
(800) 374-1600

LABEL A (LIQUID GLAZES)

AMACO® CR Series: 10, 11, 15, 30, 31, 41, 42, 50, 51, 53, 60
 AMACO® CTL Series: 1[®], 3[®], 9[®], 10[®], 11[®], 12[®], 13[®], 15[®], 31[®], 32[®], 36[®], 41[®], 42[®], 43[®], 61[®], 65[®]
 AMACO® DG Series: 1[®], 11[®], 15[®], 20[®], 21[®], 23[®], 26[®], 27[®], 30[®], 40[®], 41[®], 42[®], 50[®], 51[®], 52[®], 53[®], 54[®], 55[®], 56[®], 57[®], 58[®], 59[®], 62[®]
 AMACO® Dipping Glaze: DC-10[®],

AMACO® F Series: 1[®], 10[®], 11[®], 15[®], 20[®], 21[®], 22[®], 23[®], 25[®], 30[®], 31[®], 40[®], 41[®], 42[®], 43[®], 50[®], 51[®], 52[®], 53[®], 54[®], 55[®], 56[®], 57[®], 58[®], 60, 61[®], 65[®], 66[®], 70[®], 71[®]
 AMACO® HF Series: 1[®], 9[®], 10[®], 11[®], 12[®], 13[®], 14[®], 17[®], 18[®], 21[®], 22[®], 23[®], 24[®], 30[®], 31[®], 32[®], 36[®], 37[®], 41[®], 50[®], 51[®], 52[®], 53[®], 54[®], 55[®], 56[®], 57[®], 58[®], 60[®], 62[®], 63[®]
 AMACO® LG Series: 1[®], 10[®], 11[®], 14[®], 20[®], 21[®], 23[®], 24[®], 30[®],

34[®], 36[®], 40[®], 42[®], 44[®], 48[®], 50[®], 51[®], 52[®], 54[®], 55[®], 60[®], 61[®], 62[®], 65[®], 760[®]
 AMACO® LM Series: 1[®], 10[®], 11[®], 15[®], 16[®], 20[®], 25[®], 30[®], 32[®], 42[®], 46[®], 50[®], 52[®], 53[®], 54[®], 55[®], 56[®], 57[®], 58[®], 60[®], 65[®], 66[®], 202[®], 230[®], 231[®], 244[®]
 AMACO® LT Series: 13[®], 15[®], 17, 30, 32, 34, 113, 132[®], 147[®], 161[®], 166[®]
 AMACO® O Series: 10[®], 11[®], 12[®], 30[®], 42[®], 52[®], 54[®], 57[®], 60[®]
 AMACO® Snowfluff

AMACO® SP-Arroya Series: White, Black, Brown
 AMACO® SP Series: 400, Overdrift
 AMACO® ST Series: 20, 30, 33, 40, 51, 53, 55, 56, 65
 AMACO® TH Series: 1[®], 2[®] (High Fire Texturizers)
 AMACO® TL Series: 1 (Low Fire Texturizer)
 AMACO® UT Series: 1001, 1002, 1003, 1004, 1005, 1006, 1007, 1008, 1009, 1010, 1011, 1012, 1013, 1014, 1015, 1016

LABEL A (DRY GLAZES)

AMACO® HF Series: 1[®], 9[®], 10[®], 11[®], 13[®], 14[®], 18[®], 21[®], 22[®], 23[®], 24[®], 36[®], 37[®], 41[®], 50[®]
 AMACO® LG Series: 1[®], 10[®], 11[®], 23[®], 24[®], 30[®], 34[®], 40[®], 50[®], 52[®], 54[®], 60[®], 61[®], 62[®], 65[®], 760[®]



AMACO Dry Gloss Glazes
LG Series



NON-TOXIC



LG-11
Dinnerware safe when applied and fired to the recommended temperature on label.
LEADFREE

OPAQUE WHITE
1 LB. NET WT.

MIXING INSTRUCTIONS: Do not produce dust. Do not empty glaze powder into another container. Add water gradually into the jar, stirring slowly. The glaze level will drop in the jars as you mix in the water, allowing for more water additions until a creamy consistency is achieved. To insure a homogeneous mixture, use a small glaze mixer attached to a hand drill. Although every glaze formula will have its own special water requirements, a basic recipe is to add eleven ounces of water by weight to one pound of dry glaze. One pound of AMACO® dry glaze will make approximately one pint of liquid glaze. Try not to let the glaze become thinner than needed, since the lower the viscosity, the greater the chance that heavy glaze particles will settle out. AMACO® glazes have a sufficient suspending agent to prevent settling unless an excessive amount of water is added. Store prepared glazes in their own airtight jars.

Request Material Safety Data Sheets when using in manufacturing. Tableware producers must test all finished ware to establish dinnerware status, due to possible variations in firing temperature and contamination.



Reorder# 37115M
0 39672 37115 6
LG-06

American Art Clay Co., Inc.
Indianapolis, Indiana 46222
(800) 374-1600

LABEL E, EE

CL CAUTIONARY LABEL (contains one or more of the following ingredients: lead silicate frit, copper, lithium, cobalt, cadmium and/or manganese).

These glazes are **NOT RECOMMENDED** for use in health care facilities, nursing homes, home, home studios, or by women who are pregnant or expecting pregnancy, or by children in grades K-6.

Some of these glazes are dinnerware safe. Lead release information differs for each glaze. The catalog or current label will provide the correct information.

See appendix III, page 42, for additional information. Lead containing glazes should not be spray applied. Suitable lead-free AMACO® glazes are available.

LABEL E, EE (LIQUID GLAZES)

AMACO® CTL Series: 33, 50[®], 54[®]
 AMACO® Fine Art Glazes:
 SP-510, SP-2001
 AMACO® L Series: 511, 512, 514,
 516, 518[®]
 AMACO® LG Series: 9[®], 32, 53, 56,
 66
 AMACO® LT Series: 24, 31, 115,
 121, 122, 130, 133, 142, 144,
 AMACO® SP Series: 10[®]

**Visit our AMACO®
 web site for
 the latest safety
 information:
www.amaco.com**

AMACO® Textured Alligator Liquid Glazes
 LT Series

E



LT-24 ANTIQUE BLUE
 Not for use on surfaces which may come into contact with food or drink.
 16 FL. OZ. (472 ML)

ACMI CL
 Conforms to ASTM D-4236

NOT FOR SPRAY APPLICATION.

DIRECTIONS: Shake and stir well before using. Thin with water if needed or to improve brushability, add AMACO® Gum Solution. Apply 3 brush coats to properly matured Cone 04 bisque. Fire to Cone 05. Slow firing of this glaze will result in an all over crystal matt surface, while fast firing will produce a gloss background with scattered crystal formulation.

WARNING: May be harmful if swallowed. Cancer agent based on experimental data. Ingestion may cause anemia, damage to the heart and lungs, damage to the testes, nervous system, kidneys, liver or bone marrow. Exposure may result in difficulty with child bearing or harm to the fetus. Contains: One or more of the following ingredients: lead silicate frit, copper and/or cobalt. Avoid ingestion. Wash hands immediately after use. When using do not eat, drink or smoke. Wear apron. Do not use if pregnant or considering pregnancy. KEEP OUT OF REACH OF CHILDREN. NOT FOR USE IN HEALTH CARE FACILITIES. If swallowed get prompt medical attention. For further health information contact a poison control center. KEEP IN ORIGINAL CONTAINER.

American Art Clay Co., Inc.
 Indianapolis, Indiana 46222
 (800) 374-1600

Request Material Safety Data Sheets when using in manufacturing. Tableware producers must test all finished ware to establish dinnerware status, due to possible variations in firing temperature and contamination.

Barcode: 39337C
 0 159672 39337 0
 LT-03

AMACO® Liquid Gloss Glazes
 LG Series

EE



LG-53 FLAME
 Not for use on surfaces which may come into contact with food or drink.
 16 FL. OZ. (472 ML)

ACMI CL
 Conforms to ASTM D-4236

NOT FOR SPRAY APPLICATION.

DIRECTIONS: Shake and stir well before using. Thin with water if needed. Apply 3 to 4 brush coats to properly matured Cone 04 bisque. Fire fast with peephole plugs open, allow plenty of space around pieces during firing to facilitate air circulation. Fire to witness Cone 07-06.

WARNING: May be harmful if swallowed. Cancer agent based on experimental data. Ingestion may cause damage to the kidneys, testes, nervous system or bone marrow. Exposure may result in difficulty with child bearing or harm to the fetus. Contains: lead silicate frit and cadmium. Avoid ingestion. Wash hands immediately after use. When using do not eat, drink or smoke. Wear apron. Do not use if pregnant or considering pregnancy. KEEP OUT OF REACH OF CHILDREN. NOT FOR USE IN HEALTH CARE FACILITIES. If swallowed get prompt medical attention. For further health information contact a poison control center. KEEP IN ORIGINAL CONTAINER.

American Art Clay Co., Inc.
 Indianapolis, Indiana 46222
 (800) 374-1600

Request Material Safety Data Sheets when using in manufacturing. Tableware producers must test all finished ware to establish dinnerware status, due to possible variations in firing temperature and contamination.

Barcode: 39150C
 0 159672 39150 6
 LG-05

LABEL F

CL CAUTIONARY LABEL (contains one or both ingredients: copper and/or cobalt).

These glazes are also **NOT RECOMMENDED** for children in grades K-6. Some of these glazes are dinnerware safe. Refer to the catalog or current label for information about the individual lead release of each glaze.

See Appendix III, p. 42 for additional information. Glazes containing copper and/or cobalt should not be spray applied. Suitable AMACO® glazes are available.

AMACO® Lead Free Liquid Glazes
 F Series

F



F-26 AQUA LEADFREE
 Dinnerware safe when applied and fired to the recommended temperature on label.
 16 FL. OZ. (472 ml)

ACMI CL
 Conforms to ASTM D-4236

NOT FOR SPRAY APPLICATION.

DIRECTIONS: Shake and stir well before using. Thin with water if needed or to improve brushability, add AMACO® Gum Solution. Apply 3 brush coats to properly matured Cone 04 bisque. Fire to witness Cone 05. This glaze may also be applied by sponging, dipping or pouring. Request Material Safety Data Sheets when using in manufacturing. Tableware producers must test all finished ware to establish dinnerware status, due to possible variations in firing temperature and contamination.

WARNING: May be harmful if swallowed. Ingestion may cause anemia, damage to the kidneys or liver, damage to the heart and lungs. Contains: One or both ingredients: copper and/or cobalt. Avoid ingestion. Wash hands immediately after use. When using do not eat, drink or smoke. KEEP OUT OF REACH OF CHILDREN. NOT FOR USE IN HEALTH CARE FACILITIES. If swallowed get prompt medical attention. For further health information contact a poison control center. KEEP IN ORIGINAL CONTAINER.

American Art Clay Co., Inc.
 Indianapolis, Indiana 46222
 (800) 374-1600

Barcode: 39357M
 0 159672 39357 9
 F-03

LABEL F (LIQUID GLAZES)

AMACO® CR Series: 26
 AMACO® CTL Series: 20[®], 26[®]
 AMACO® DG Series: 25[®]

AMACO® F Series: 26[®], 27[®], 47
 AMACO® LG Series: 2[®], 25[®], 26[®],
 27[®], 45[®], 46[®]
 AMACO® LT Series: 3, 12[®], 16[®],
 22[®], 48

AMACO® O Series: 2[®], 20[®], 21[®],
 23[®], 26[®]
 AMACO® Sahara HF Series: 26[®]

LABEL F (DRY GLAZES)

AMACO® LG Series: 2[®], 25[®], 26[®],
 45[®], 46
 AMACO® Sahara HF Series: 26[®]

AMACO® Dry Gloss Glazes
 LG Series

F



LG-26 TURQUOISE
 Dinnerware safe when applied and fired to the recommended temperature on label.
 LEADFREE
 1 LB. NET WT.

ACMI CL
 Conforms to ASTM D-4236

NOT FOR SPRAY APPLICATION.

MIXING INSTRUCTIONS: Do not produce dust. Do not empty glaze powder into another container. Add water gradually into the jar, stirring slowly. The glaze level will drop in the jar as you mix in the water, allowing for more water additions until a creamy consistency is achieved. To insure a homogeneous mixture, use a small glaze mixer attached to a hand drill. Although every glaze formula will have its own special water requirements, a basic recipe is to add eleven ounces of water by weight to one pound of dry glaze. One pound of AMACO® dry glaze will make approximately one pint of liquid glaze. Try not to let the glaze become thinner than needed, since the lower the viscosity, the greater the chance that heavy glaze particles will settle out. AMACO® glazes have a sufficient suspending agent to prevent settling unless an excessive amount of water is added. Store prepared glazes in their own airtight jars.

DIRECTIONS: After following mixing instructions, shake and stir well before using. Thin with water if needed or to improve brushability, add AMACO® Gum Solution. Apply 3 brush coats to properly matured Cone 04 bisque. Fire to witness Cone 05. This glaze may be applied by sponging, dipping or pouring. Request Material Safety Data Sheets when using in manufacturing. Tableware producers must test all finished ware to establish dinnerware status, due to possible variations in firing temperature and contamination.

WARNING: May be harmful if swallowed. Ingestion may cause anemia, damage to the kidneys or liver, damage to the heart and lungs. Contains one or both ingredients: copper and/or cobalt. Avoid ingestion. Wash hands immediately after use. When using do not eat, drink or smoke. KEEP OUT OF REACH OF CHILDREN. NOT FOR USE IN HEALTH CARE FACILITIES. HOME OR HOME STUDIO. If swallowed get prompt medical attention. For further health information contact a poison control center. KEEP IN ORIGINAL CONTAINER.

American Art Clay Co., Inc.
 Indianapolis, Indiana 46222
 (800) 374-1600

Barcode: 37110G
 0 159672 37110 1
 LG-09

DRY GLAZES are packaged in non-breakable jars for easy and **SAFE** mixing.

When mixing a dry glaze, do not empty glaze into another container. **DO NOT PRODUCE DUST.** Follow mixing instructions on the label.

Health information differs for each glaze. Refer to the catalog or label for correct information.

AMACO® glazes are available in either a liquid or dry powder form. Both liquid and dry powder glazes are supplied in non-breakable plastic jars. Liquid glazes are homogenized to the correct consistency and are ready for easy brushing. Since dry glazes contain a suspending agent, only water needs to be added to the jar, according to directions on the label. Always mix and store dry glazes in their original containers, this will prevent exposure to dust while mixing and the jar will be correctly identified for later use.

AMACO® glazes and underglazes manufactured, packaged and purchased prior to the adoption of the labeling described in this booklet, display proper health information at the time of packaging. For each glaze or underglaze, refer to the individual imprint information on the label.

AMACO®, the leading manufacturer of lead free glazes, has the advantage of many years of formulating experience in its ongoing research and development efforts to bring a safer product to the market.

But it is practically impossible to produce an entire line of glazes and underglazes that are Non-Toxic. Certain toxic materials are needed to produce some special effects and certain desired colors.

The addition of lead in a glaze, which is always added as part of a glass frit compound to reduce its

solubility, gives it a flowing effect in the firing, which helps cover up imperfections in application. It also lends a very evident high gloss and smoothness to the finished surface, which is not achievable with a lead free glaze. Lead is also used to produce textured art glazes.

Heavy metal oxides such as copper, cobalt and manganese are the only ingredients to add color to a glaze. Solubility of these colorants is improved when they are compounded and used as a stain, but this is usually only possible in smaller percentages which results in lighter colors. Bright reds and oranges would be unavailable if lead and cadmium were not used in these glazes.

In spite of all these and other technical difficulties, AMACO's research engineers continue to look for lead free glaze compositions that will produce a product that is more flowing, glossier and has a wide firing temperature range.

In recent years, new European technology has become available for lead free cadmium colors. AMACO® was the leading producer to use these reds and oranges in lead free, Non-Toxic glazes and underglazes.

Though these new colors are not as bright as the old lead/cadmium pigments, they are beautiful and safe. The only performance difference between AMACO® leaded and lead free glazes, is that lead free glazes have a narrower firing range and the firing temperature should be carefully monitored. Unlike lead-bearing glazes, where a little under-firing or over-firing may not make a difference, low fire lead free glazes must reach cone 05 (1915°F, 1046°C) to mature. The other fact to consider is that lead free glazes do not flow

as much in the firing as most lead bearing glazes will. Therefore, if application is made with a brush, a crisscross brush pattern is recommended for even application. These minor adjustments are all that is necessary to use safe glazes with perfect results. **NOTE:** If you are experiencing under-firing when using a Kiln-Sitter® during the firing of AMACO® Clays and AMACO® Glazes, use the next cone higher than recommended.

Some professional potters like to mix their own glazes from raw materials, but even among professionals there is a growing trend toward using commercially prepared glazes for both safety and convenience.

AMACO® does not sell any chemicals for glaze preparation and recommends that only prepared glazes be used in a classroom. Ceramic artists, like painters or sculptors, express their art in their own medium. For this reason, potters are using more commercially prepared glazes and are concerning themselves more with their own creativity and less with the technical aspect of formulating clay and glazes. It may be technically impossible for the individual who formulates his own clay and/or glazes to achieve the desired artistic results and still use all Non-Toxic ingredients. With safe, quality controlled commercial products, potters can now concentrate on creating artistic pieces just as other artists who work in other media have always done.

Potters and ceramic producers of utilitarian dinnerware must be aware of laws and regulations concerning dinnerware products.

There are a number of Federal and State laws and regulations that have been introduced and are still being introduced requiring

labeling of dinnerware and non-dinnerware products.

These laws sometimes vary from state to state and place the responsibility on the producer to inform the customer whether or not the ware is safe for use as dinnerware. Excessive penalties are usually imposed on those who do not abide by these laws. One of these regulations is the California Health and Safety Code Section 25887, which requires that each dinnerware piece sold should be permanently and indelibly marked with the manufacturer's name. By that, they mean the name should be either stamped into the clay or fired on.

When using different dinnerware glazes, avoid intermixing them. Always fire to the recommended firing temperature and for extra precaution it is wise to send test samples to an independent laboratory that can perform lead release tests according to FDA Standard listed on page 6.

AMACO® even recommends lead free glazes to be tested for dinnerware before being sold as such.

AMACO's Technical Services staff will be glad to supply, upon request, the information on the laboratories that would perform the tests.

Visit our
AMACO®
web site for a
complete catalog:
www.amaco.com

UNDERGLAZES

Underglazes are tested and certified in the same manner and categories as glazes. You must consider the safety of the underglazes in the jar and follow the necessary precautions of using an underglaze during application as well as the lead release information after firing (See glaze section on page 6 for further details). AMACO® underglazes are manufactured in three forms: liquid, semi-moist (pan sets and tubes) and solid (crayons and pencils).

All AMACO® underglazes are lead-free and are considered dinnerware safe when a dinnerware safe glaze is applied over them. Some AMACO® lead-free underglazes are not recommended for spray application because they contain crystalline silica.

Remember that because of the consistent quality of all AMACO® underglazes, they can be used safely if application and firing instructions are followed.



LABEL A

AP NON-TOXIC: These underglazes are completely safe for all applications, including spraying.

Visit our AMACO® web site for classroom lesson plans: www.amaco.com

AMACO®

Velvet Underglazes

V Series



V-309
Velvets have only been tested & approved as dinnerware safe when applied under LG-10. They must be retested if used under other glazes.
LEADFREE

DEEP YELLOW
16 FL. OZ. (472 ml)



Conforms to
ASTM D-4236

NON-TOXIC



DIRECTIONS: Shake and stir well before using. For solid coverage apply 3 even coats to greenware or bisque. Fire to mature Cone 05-04. Velvets can also be used for shading and detail work. If Velvets are glazed over, the colors intensify. Thin with water if necessary.

Request Material Safety Data Sheets when using in manufacturing. Tableware producers must test all finished ware to establish dinnerware status, due to possible variations in firing temperature and contamination.

American Art Clay Co., Inc.
Indianapolis, Indiana 46222
(800) 374-1600

AMACO® DV Series*: 3302[®], 3308[®], 3316[®], 3320[®], 3325[®], 3327[®], 3328[®], 3334[®], 3354[®], 3360[®], 3367[®], 3368[®], 3369[®], 3371[®], 3372[®], 3374[®]

AMACO® GDC Series: 1[®], 10[®], 15[®], 20[®], 21[®], 25[®], 26[®], 27[®], 28[®], 30[®], 31[®], 32[®], 33[®], 36[®], 38[®], 40[®], 41[®], 42[®], 43[®], 45[®], 47[®], 50[®], 51[®], 52[®], 53[®], 54[®], 55[®], 56[®], 57[®], 58[®], 59[®], 60[®], 62[®], 63[®], 64[®], 65[®]

AMACO® LUG Series*: 1[®], 10[®], 15[®], 20[®], 21[®], 22[®], 25[®], 26[®], 30[®], 31[®], 40[®], 41[®], 42[®], 43[®], 50[®], 51[®], 52[®], 53[®], 54[®], 55[®], 56[®], 60[®], 61[®], 65[®]

AMACO® Semi-Moist Pan Set #108: Black, Blue-Green, Dark Blue, Dark Green, Light Brown, Light Yellow, Maroon, White

AMACO® Semi-Moist Pan Set #109: Bright Yellow, Irish Green, Lilac, Mahogany Brown, Medium

Blue, Pink, Turquoise, Warm Gray

AMACO® Semi-Moist Pan Set #110: Aqua, Chartreuse, Light Blue, Orange, Peach, Purple, Rose, Suntan

AMACO® Semi-Moist Pan Set #111: Amethyst, Electric Blue, Hunter Green, Light Red, Real Orange, Red, Salmon, Violet

AMACO® SE Series*: 701[®], 702[®], 710[®], 720[®], 730[®], 731[®], 732[®], 740[®], 760[®]

AMACO® Tube Set #408: Black, Blue-Green, Dark Blue, Dark Green, Light Brown, Light Yellow, Maroon, White

AMACO® Tube Set #409: Bright Yellow, Irish Green, Lilac, Mahogany Brown, Medium Blue, Pink, Turquoise, Warm Gray

AMACO® Tube Set #410: Aqua, Chartreuse, Light Blue, Orange,

Peach, Purple, Rose, Suntan
AMACO® Tube Set #411: Amethyst, Electric Blue, Hunter Green, Light Red, Real Orange, Red, Salmon, Violet

AMACO® Underglaze Chalk Crayons Set #208: Black, Brown, Dark Green, Rose, Turquoise, White, Yellow
AMACO® Underglaze Chalk Crayons Set #209: Blue-Green, Dark Brown, Gray, Light Brown, Lilac, Medium Blue, Medium Green, Yellow-Green

AMACO® Underglaze Pencils: Black, Brown, Green, Rose, Yellow

AMACO® V Series*: 301[®], 302[®], 303[®], 304[®], 308[®], 309[®], 310[®], 313[®], 314[®], 315[®], 316[®], 317[®], 318[®], 320[®], 321[®], 322[®], 323[®], 325[®], 326[®], 327[®], 328[®], 332[®], 333[®], 334[®], 336[®], 341[®], 343[®], 345[®], 350[®], 353[®],

354[®], 355[®], 356[®], 357[®], 360[®], 361[®], 366[®], 367[®], 368[®], 369[®], 370[®], 371[®], 372[®], 373[®], 374[®], 375[®], 376[®], 380[®], 381[®], 382[®], 383[®], 384[®], 385[®], 386[®]

AMACO® V-1-S Series*: 1308[®], 1309[®], 1313[®], 1314[®], 1317[®], 1322[®], 1326[®], 1336[®], 1345[®], 1353[®], 1360[®], 1370[®]

* AMACO® LUG, SE, V, V-1-S, and DV Series Underglazes have only been tested and approved as dinnerware safe when applied and fired under AMACO® LG-10 Clear Glaze. Other glazes may also be used. Tableware producers must have all finished ware tested and approved as safe for dinnerware through a certified laboratory due to possible variations in firing temperature and contamination.

LABEL F

CL CAUTIONARY LABEL (contains one or both ingredients: copper and/or cobalt). These underglazes are also **NOT RECOMMENDED** for children in grades K-6. Some of these underglazes are dinnerware safe. Refer to the catalog or current label for information about the individual lead release of each underglaze.

See appendix III, p. 42, for additional information. Underglazes containing copper and/or cobalt should not be spray applied. Suitable AMACO® underglazes are available.

AMACO® SS Series: 201[®], 202[®], 203[®], 204[®], 205[®], 206[®]
AMACO® Underglaze Chalk Crayons Set #208: Dark Blue
AMACO® Underglaze Pencils: Blue

AMACO Underglaze Decorating Colors

LUG Series



Since 1919

American Art Clay Co., Inc.
Indianapolis, Indiana 46222
(800) 374-1600



LUG-55 **PURPLE**
LUG SERIES HAVE ONLY BEEN TESTED & APPROVED AS DINNERWARE SAFE WHEN FIRED UNDER LG-10. THEY MUST BE RETESTED IF USED UNDER OTHER GLAZES.
LEADFREE **16 FL. OZ. (472 ML)**



Conforms to
ASTM D-4236

NOT FOR SPRAY APPLICATION.



Reorder# 41190R
0 596724 1190 6

LUG-04

DIRECTIONS: Stir thoroughly. Thin with water. Brush or sponge 1 to 2 coats on greenware or bisque. Water color effects when diluted. Fire to maturing temperature of clay and covering glaze. Request Material Safety Data Sheets when using in manufacturing.

WARNING: May be harmful if swallowed. Exposure may cause damage to the heart and lungs. Contains: cobalt. Avoid ingestion. Wash hands immediately after use. When using do not eat, drink, or smoke. **KEEP OUT OF REACH OF CHILDREN. NOT FOR USE IN HEALTH CARE FACILITIES.** If swallowed get prompt medical attention. For further health information contact a poison control center. **KEEP IN ORIGINAL CONTAINER.**

Tableware producers must test all finished ware to establish dinnerware status, due to possible variations in firing temperature and contamination.

SPECIALTY UNDERGLAZES

Series SS Sun Strokes are specially formulated underglazes in vivid shades of red, yellow and orange. They should be applied on bisque and glazed at the same time. If left unglazed the surface is shiny. Clear glaze smooths out and brightens the colors.

All Sun Strokes are dinnerware safe when covered with SP-10 clear glaze.

CL CAUTIONARY LABEL (contains one or more of the following ingredients: lead silicate frit, copper, lithium, cobalt, cadmium and/or manganese).

These underglazes are **NOT RECOM-**

MENDED for use in health care facilities, nursing homes, home, home studios, or by women who are pregnant or expecting pregnancy, or by children in grades K-6. Lead release information differs for each underglaze. The catalog or current label will provide the correct information.

See appendix III, page 42, for additional information. Lead containing underglazes should not be spray applied. Suitable lead-free AMACO® underglazes are available.

AMACO® SS Series: 201[®], 202[®], 203[®], 204[®], 205[®], 206[®]



OVERGLAZES

Overglazes are designed to be applied to glazed pottery and fired to a low temperature of cone 018. AMACO® Overglazes are available in semi-moist pan sets for use in pottery, glass and metal enameling. Overglazes also are available in tubes known as Versa Colors which were specifically developed for silk screen printing on glazed tiles in addition to the other uses of overglazes. AMACO® Oil Base Versa Color overglazes contain some lead bearing compounds while AMACO® Water Base Versa Color and Opalescent

overglazes are **LEAD-FREE**. However, we do not recommend the use of either series on food and drink containers due to variations in firing temperature and contamination.

The following is a list of AMACO® Overglazes. Please refer to catalog and current label information for specific details on each item.

AP NON-TOXIC

AMACO® Semi-Moist Pan Set #508:

Red, Red-Brown

AMACO® Semi-Moist Pan Set #509:

Yellow-Green

AMACO® Versa Color WB Series —

Tubes: Black, Brown, Green, Orange, Red, Teal, White, Yellow
AMACO® Versa Color WB Opalescent Series — Tubes: All eight colors

CL CAUTIONARY LABEL

AMACO® Semi-Moist Overglaze

Pan Set #508: Black, Blue, Green, Orange, White, Yellow

AMACO® Semi-Moist Overglaze

Pan Set #509: Chocolate Brown, Gray, Peach, Pink, Special Blue, Turquoise, Violet

AMACO® Versa Color OB Series —

Tubes and Jars: All 8 Colors

Glass and metal enamel ceramic

decorating colors are applied on glassware and fired metal enamel surfaces. Decorated glassware is placed in a cool kiln and fired slowly to 1121°F (60°C). Decorated metal enamel pieces are placed in a preheated kiln and fired for approximately 1½ minutes at 1300°F (704°C).

CL CAUTIONARY LABEL

AMACO® Semi-Moist Glass and Metal Enamel Decorating Colors Set #308: Black, Blue, Green, Pink, Red, Turquoise, White, Yellow

AEROSOL SPRAYS AND SOLVENTS

Health and safety experts agree that aerosol sprays and solvents are among the more dangerous art materials if not used properly. Any aerosol spray fixative should be used only in a well-ventilated area. Avoid breathing vapor, dust or mist. Use a

window exhaust fan or spray booth vented to the outside to remove vapors and assure cross ventilation. Refer to the label for specific information. Solvents should also be used only in a well-ventilated area away from any type of heat or fire. Common sense and good house-

keeping rules should always be followed. These products should not be used by children, pregnant women, or in health care facilities.

When spraying oil or solvent base products you **MUST** use extreme caution. Wear protective gloves. Use only in a well ventilated area, away

from heat or open flames. Use a spray booth equipped with an explosion proof motor and a strong fan, that will exhaust to the outside. Wear a NIOSH approved respirator for organic vapors. Always follow OSHA's guidelines for use of solvent containing products.

SPRAYING AND AIRBRUSHING



The technique of airbrushing underglazes and glazes onto greenware or bisque is sometimes used in ceramics. If this technique should be taught to high school or college level ceramic students, safe and proper rules should also be taught and enforced in any classroom or studio.

Airbrushing should be done in an exhaust ventilated spray booth specifically designed for this purpose. NIOSH approved dust masks should also be worn for safety. Make sure that your respirator has an airtight seal. Women may need to use respirators especially manufactured for use by people with small face sizes. Men should be clean shaven. Occupational health programs can offer formal testing for respirator fit. For a quick check of respirator fit, remove

cartridges and cover inlets with your palm. You should not be able to inhale. Wear protective clothing including hair covering that is removed before eating, drinking, or smoking or leaving work. Wash hands thoroughly, immediately after spraying and removing protective clothes. Do not eat, drink, or smoke in the work area. Airbrushing is an exciting ceramic decorating technique and need not be avoided if proper safety precautions are used. **Lead-containing glazes should NOT be airbrushed; there are suitable lead-free glazes for this purpose.** We do not recommend airbrushing for pre-school and elementary age children. In high school airbrushing should only be introduced under strict supervision.

*If users feel they must spray glazes containing lead or silica, use extreme caution. When spraying these glazes in production, extreme caution **MUST** be taken. Use only a NIOSH approved particulate respirator for dust and water mist and replace it often. A safety supply house is the best source of suitable equipment. (For more detailed information about masks for protection against dust and mist contact: Dept. of Health & Human Services, National Institute For Occupational Safety & Health (NIOSH), Mail Stop C-19, 4676 Columbia Parkway, Cincinnati, OH 45226, (800) 356-4674, (513) 533-8328 [Outside U.S.]*

Use a spray booth equipped with a strong fan that exhausts all glaze mists away from the breathing zone. Replace all spray booth filters often. Use the same precautions during filter changes as when handling dry glazes. Wear protective clothing that is removed before eating, drinking, smoking or leaving work. Wash hands and arms thoroughly after spraying and removing protective clothes. Do not smoke or eat in work area. If leaded glaze spraying is a regular or major part of your work, regular blood-lead-level testing by your doctor is necessary. Follow all OSHA guidelines for use of heavy metal products.

The above information references ASTM C1192, "Standard Guide For Spraying Ceramic Glazes Safely."

KILN FIRING GUIDELINES

The use of a kiln for firing ceramics has been proven safe if a few common sense precautions are taken.

1. Be sure that your kiln is properly installed and that installation meets all local electrical codes. Check individual kiln installation instructions to be sure that your kiln is the required distance from a wall. This distance may vary from 12" to 18" depending on the type of kiln. Kiln installation should be performed by a qualified electrician.
2. For used kilns, contact manufacturer for installation instructions.
3. Electric hobby kilns heat ceramic pieces to a very high temperature. **Any electric appliance can present an electrocution hazard if operated in contact with water.** Do not operate a kiln in a wet area. **To prevent burns or damage to your work, do not remove hot pieces from the kiln.** Do not allow children near the kiln.
4. Do not plug in or unplug the kiln unless the circuit is turned off. Turn all switches to OFF before loading or unloading the kiln. Do not open the lid or door with the kiln turned on.
5. Do not leave papers or combustibles around the kiln, or place objects on the kiln while firing. Always unplug the kiln while making any repairs.
6. Do not try to unload the kiln until the outside of the kiln is cool to the touch and the pieces can be easily touched by hand. Removing hot pieces presents risks of burns or fires or crazing of glazed surfaces.
7. When unloading a kiln, be careful of the stilt marks on glazed ceramic pieces. They can be sharp and be smoothed as soon as possible with a grinding wheel or stone. Wear safety glasses while grinding off stilt marks.
8. Kilns — both electric and fuel-fired — should be vented. Proper means of ventilation are described later in this section.
9. If at all possible, it is recommended that the kiln be kept in a separate room to avoid excess heat in the work areas. This also helps to prevent accidents if children are present.
10. Wear dark-shaded glasses (shade number 1.7-3.0) for looking into peephole and protective kiln gloves when handling a hot kiln. (See "Personal Protective Equipment", page 4)
11. Only a qualified adult should ever be allowed to operate or touch a kiln. The question of toxic emissions from electric kiln firings was studied by Professor Parker Reist of the Department of Environmental Sciences at the

University of North Carolina. His tests were done to assist the American Society for Testing and Materials, in developing an appendix to the ASTM Art Material Labeling Standard. This appendix outlines safe operation of electric kilns used to fire ceramic materials.

The results of Professor Reist's study indicate a **SAFE ENVIRONMENT** during kiln firing in a ventilated area. In a totally unventilated area, there was evidence of carbon monoxide build-up during firing. When ventilation was supplied, the carbon monoxide exposure was substantially reduced. This indicates that required ventilation of an indoor kiln results in a safe environment and should be considered a necessity.

The ASTM Standard C1023 Appendix for ventilating an electric kiln area states: "Ventilation is recommended when firing an electric kiln. Adequate ventilation may be achieved by means of air exchange through use of cross ventilation, exhaust hoods or self-contained air handling systems. To determine the appropriate ventilation, it is recommended that you consult a local licensed Heating, Ventilation and Air Conditioning Contractor." The standard goes on to warn "Fossil fuel kilns (Oil, Gas, Coal, Wood, etc.) must have outside ventilation. These kilns are not covered under the above statement and the user should contact the kiln manufacturer and a local, licensed Heating, Ventilation and Air Conditioning contractor for proper installation."

GREENWARE: In greenware firings, exposure concentrations to both formaldehyde and sulfur dioxide appear to be **WELL BELOW THE THRESHOLD LIMIT VALUES (TLV)** when ventilation is provided. For your protection, AMACO® clay bodies are formulated with ingredients that have the least amount of contaminants: All AMACO® clays have a low sulfur content to give added protection from release of sulfur dioxide.

GLAZES: In glaze firings, without exception, metal samples collected from the air around the kilns during firing showed **LITTLE, IF ANY, CONTAMINANTS** present.

A free copy of the full report may be obtained by writing to: Kiln Test, Box 22328, Indianapolis, IN 46222.

AMACO® offers four excellent kiln ventilation systems that will help your kiln to achieve truer, consistent colors and even chamber temperatures, while eliminating the potentially dangerous fumes that may be emitted during firing.

LOADING AND FIRING THE KILN

Before loading, make sure the kiln is turned off and cold.

To start, use a 2" or 3" kiln support to place under the bottom shelf of the kiln. Do not fire anything on the floor of the kiln. First of all the bottom will always be cooler than the rest of the chamber, and also you would be running the risk of having your glazes run off onto the floor and damaging it, in case of over-firing.

Always use shelves that have been covered with Kiln Wash on their upper side. After you have the first shelf in place, and if you have enough pieces that will require multiple shelves, then choose your ware so that you can fire the larger (taller) pieces on the lower shelf and the smaller (shorter) pieces on the upper shelves.

This arrangement will help distribute the heat better. Since heat moves up, this will open up the space in the lower part of the kiln making a better air circulation, and evenly distribute the heat throughout the kiln.

If you are firing a load of Bisque

(the first firing) then you can load the kiln very tight, even place pieces one into the other (see photo #1). When you have the urge to put as many pieces as possible in the kiln, remember to leave room to place the cone. The cone should have enough room for it to bend without touching the ware (see photos 1 and 2).

When you are firing glazed ware you must pay close attention to leave enough room between each piece. Remember that if pieces touch they will stick together. Place the ware 1" to 2" apart and away from the wall of the kiln (see photo #2).

If you have a dry foot on your pieces, (you do not have any glaze on the foot) then you can place them directly on the shelf that has been covered with kiln wash. Or you can place them on stilts, if you have glaze on the bottom. Make sure the pieces are well balanced on the stilts and that they will not tumble off.

Once the pieces are glaze fired you can grind off the stilts marks

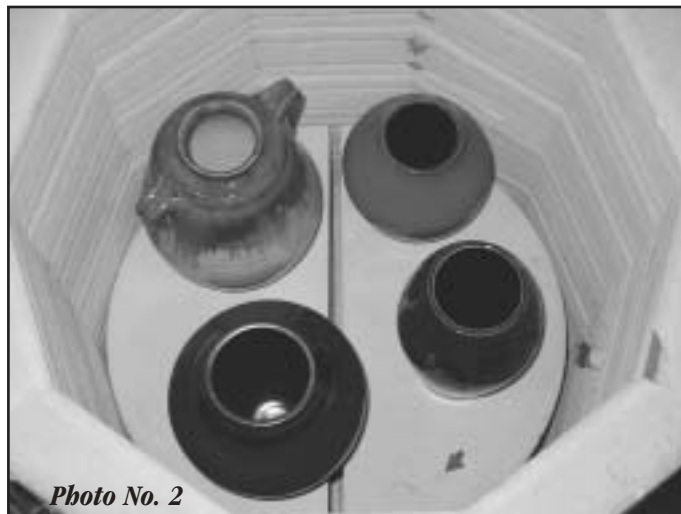

Photo No. 2

either by using a hand-held carborundum stone or on an electric grinder. Do not forget to wear goggles when you do grinding and remember that broken off stilts can be very sharp. Therefore, take precautions not to cut yourself. See photos 3 and 4.

Most kilns today have either a kiln sitter or an electronic control. Both are fairly good indicators of

and see your witness cone bend as you monitor the rise in temperature. A proper firing will cause the cone to bend to a 90° angle.

Junior cones or bars are used in the kiln sitter and will shut off the kiln automatically as they absorb the heat and bend. However, kiln sitters may not be very accurate unless they are adjusted to shut off at the same time as the witness

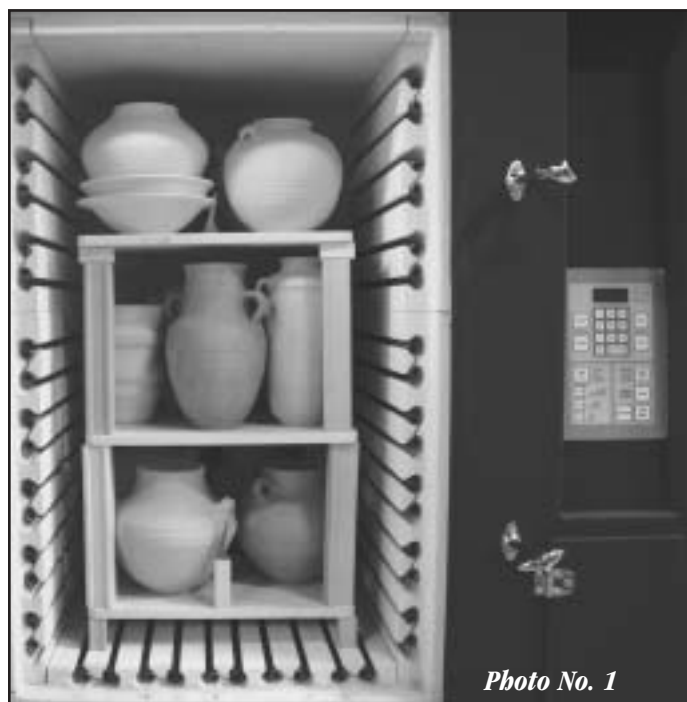

Photo No. 1



Photo No. 3

temperature, and practical because they will shut off the kiln automatically when the firing is completed. However using guide cones gives you the most accurate temperature reading. Use either the self-supporting or the regular ones. It is advisable to place a cone on every shelf in the kiln, especially when you first start using the kiln. This will show you any temperature difference in your kiln from top to bottom.

You will need to place the witness cone behind the middle peephole. When temperature rises in the kiln you can look through the peephole,



Photo No. 4

cone bends. Or since they always tend to shut off early, use a higher temperature cone in the sitter. For example: If you want to fire to cone 05 then put a cone 04 in the sitter. Compare this to a witness cone 05 in the kiln during the same firing.

Never open the kiln during firing. When the kiln is off leave it closed overnight to cool. Open the kiln the next day and make sure it is cool to the touch before you handle the ware to unload it.

Always make sure the kiln is off before you open it.

KILN VENTS

All four KilnVents feature a patented down draft system that draws oxygen into and through the kiln while diluting the fumes with room air and discharging them outdoors via flexible aluminum ducting. Cool-down time is also reduced by 2-4 hours, often allowing firing the very next day.

Keeping a kiln in a separate room from the studio or classroom is definitely the best idea. This would help remove the possibility of burn accidents from children (or adults) touching a hot kiln. The outside of a kiln during normal firing times will not get nearly as hot as the inside gets, but it does get hot. The outside of an octagon or round kiln will get hotter faster than the outside of a square kiln because of different insulation methods. Our tests reveal that at the end of nine hours of firing at Cone 9 (2336°F, 1280°C inside the firing chamber), the surface temperature of an AMACO® square kiln will reach approximately 250°F (121°C) while the surface temperature of a round kiln will reach 450°F (232°C). For safety reasons, we therefore recommend the purchase of an AMACO® square kiln (AH, HF, FA or EC, Series) for school art departments.

All AMACO® and EXCEL® kilns are listed with the Underwriters Laboratories, Inc. (UL) and the Canadian Standards Association (CSA) and meet their rigid standards of safety with regard to casualty and fire hazards. The new “cUL” symbol is given to products listed with UL that meet the safety requirements of both Underwriters Laboratories and the Canadian Standards Association. All AMACO® kilns with Select Fire™ carry the “cUL” symbol. All AMACO® non-SF model kilns and all EXCEL® kilns carry the “UL” and “CSA” symbols. Materials, construction, and engineering undergo rigorous testing. All AMACO® kilns are re-examined regularly, part by part, by both these well-known laboratories.

We manufacture many different models of kilns offering a size and capability to meet every school or studio need. Square kilns have a useful life several times that of a round kiln. We still provide elements for AMACO® kilns manufactured more than 50 years ago. The current AMACO® catalog has full information and comparison charts on all of our kilns and we urge you to contact a qualified dealer or distributor or call us directly for additional information before purchasing a new kiln.

KILNVENT — FLOORMOUNT VERSION

The KilnVent — FloorMount Version will simultaneously vent two small kilns, two medium kilns, or one large kiln and one small kiln.



KILNVENT — SUSPENDED VERSION

The KilnVent — Suspended Version is for square electric kilns.

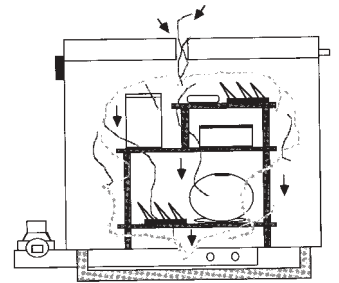

KILNVENT — STAND VERSION

The KilnVent — Stand Version is designed for round or multi-sided electric kilns.

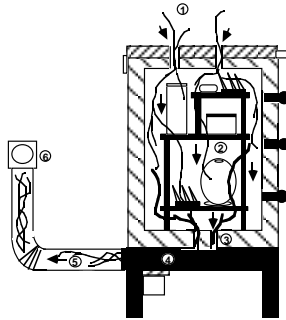

KILNVENT — KILNMOUNT VERSION

The KilnVent — KilnMount Version is for use on front loading electric kilns.

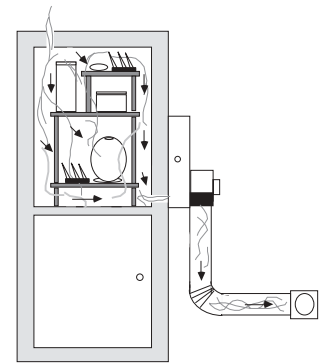

Visit our
AMACO® web site for
the latest safety information:
www.amaco.com

CERAMIC SPECIALTY PRODUCTS

The following specialty products bear the AP Non-Toxic seal.

AMACO® Kiln Wash
AMACO® Amacote
AMACO® Gum Solution
AMACO® Wax Resist

AMACO® AC-Crystals: 1, 11, 20, 26,
35, 40, 41, 46
AMACO® SP-Mender

The following specialty products bear the CL seal.

AMACO® Kiln Seal
AMACO® Plaster Separator
AMACO® AC-Crystals: 45, 52, 57, 60
AMACO® SP-Overdrift

NON-CERAMIC ART AND CRAFT MATERIALS

AMACO® produces several items that are considered craft materials and not ceramic. Our craft clays (non-hardening, low temperature oven fired and air hardened), and our assorted other craft items have all been tested and certified by The Art and Creative Materials Institute, Inc.

The following AMACO® art and craft products bear the AP Non-Toxic seal.

All-Purpose Sealer
Artone Venus Clay
Batikit® Cold Print Dye Thickner
Carving Wax
Casting Compound (Plaster of Paris)
Claycrete®
Clay Flour and Moist Clay
Easy Squeazy™ Clay
FIMO® and FIMO®*soft* Modeling Material
Flexwax
Floral Clay
Friendly Lacquer (Matte)
Friendly Plastic® Modeling Material
Genesis® Air-Dry Acrylic Gesso
Genesis® Artist Colors — All Colors
Genesis® Glazing Gel
Genesis® Mediums

Genesis® Heat-Set Permanent Satin and Matte Varnishes
Glow-In-The-Dark Acrylic Paint
Industrial Styling Clay HBX-2
Litho Sketch®
Tusche
Plate Solution
Ink-Black
Ink-Bismark Brown
Ink-Holly Green
Ink-Lasting Orange
Ink-Royal Blue
Ink-Spectral Blue
Ink-Sun Burst Red
Ink-Process Yellow
Ink-Process Red
Ink-Process Blue
Ink-Mixing Opaque White
Wax Crayons
Marblex™ Clay
Mexican™ Pottery Clay
Mix-a-Mold™
Nail Hole and Corner Filler (All Colors)
Permoplast® Clay
Plast-i-Clay®
Sculptamold®
Stonex
Super Dough™



The following AMACO® art and craft products bear the CL seal.

Batikit® Cold Water Fabric Dyes (All Colors)
Brush 'n Leaf™ (All Colors)
Crea-stone™ (White and Natural)
FIMO® Lacquer
Genesis® Brush Cleaner
Rubber Latex
Rub 'n Buff® (All Colors)

Visit our Genesis® web site
for complete instructions on
this revolutionary
new medium:
www.GenesisArtistColors.com

HOW TO USE AMACO® PRODUCTS

AMACO® glazes are used not only by professional potters and ceramists but also by hobbyists and school children. They are formulated to be easy to use by beginners and people who have little knowledge about ceramics as well as by professionals. However because of the wide variety of our glazes some differences in application and firing are required.

At AMACO® we pride ourselves in being the leader in the manufacturing of lead free glazes. When you browse through the AMACO® catalog you will find that the great majority of our prod-

ucts are lead free.

Of course we all would like to use lead free (safe glazes) if we could. AMACO® lead free glazes are very easy to use if we keep in mind certain simple requirements. Unlike leaded glazes which have a wide firing range, lead free glazes have to be fired at their recommended temperature. Overfiring sometimes may cause problems and underfiring will definitely result in unacceptable results. AMACO® lead free glazes must be fired to a mature Cone 05 (1915°F, 1046°C).

GENERAL GLAZE APPLICATION METHODS

PREPARATION

Stir and shake glazes thoroughly. The glaze should be the consistency of heavy cream and if thinning is necessary, add a few drops of water or AMACO® Gum Solution. You can work directly from the jar on a bisque which has been fired to witness Cone 04 (1940°F, 1060°C).

BRUSHING

AMACO® glazes can be applied with a flat light ox hair brush, a fitch fan brush, or you can work with a brush of your choice. Three crosshatched coats are recom-



mended. Apply glaze with a full brush. Do not work with a starved brush or scrub color into the ware. Apply three coats in a criss cross manner as evenly as possible; waiting until the water sheen disappears before applying the second and third coats.

SPONGING

Pour properly prepared gloss glaze onto a glazed tile or palette and saturate a damp silk sponge with it. Pat the glaze onto fully matured bisque surface using a pouncing method. Permit the first coat to dry thoroughly before applying the second and third coats.

DIPPING AND POURING

Although AMACO® glazes are made for brushing, you can get satisfactory results also by

pouring or dipping. Make sure the glaze is a creamy consistency. However, if you need to thin it, **DO NOT** add gum solution, add only a very little water. Excessive addition of water to glazes may cause the heavy ingredients to settle at the bottom of the jar. All AMACO® glazes are formulated with the appropriate amount of suspending agent in relation with the amount of water it requires. Glazes will remain in suspension as long as that ratio is maintained.

AMACO® GLAZES AND UNDERGLAZES

GLOSS GLAZES — LEAD FREE**

Three of the AMACO® glaze series can be described as gloss glazes: The LG, F, and DG series. These glazes will fire to a smooth glossy finish at a witness Cone 05 (1915°F, 1046°C). Always slow-fire lead free glazes for best results. The characteristics of the glaze lines whether transparent or opaque, are that they flow slightly during firing to a high gloss, while correcting most application imperfections. Good results can be obtained on all AMACO® pottery clay. For application follow general glaze application method.

For a clear, all over, covering glaze, you have a choice of LG-9 leaded glaze, LG-10 lead free, and F-10 lead free. All three have a smooth and high gloss surface. Make sure LG-10 and F-10 reach a mature witness Cone 05 (1915°F, 1046°C). You might apply them thinner than usual for best results. Two coats is usually enough.

LG-9 Clear glaze is leaded. Precautions in handling should be taken. Read the label before using. LG-9 is a beautiful glaze and is very forgiving in firing, however, for best results a mature Cone 05 (1915°F, 1046°C) firing is recommended.

Clear glaze can be used over the AMACO® LUG series, Velvet, Velvet-1-Strokes, Designer Velvet, and over the GDC Gloss decorating colors.

When gloss decorating colors are used over bisque, they need a clear gloss over them which is applied at the same time and fired once. LG-11, F-11, DG-11 Opaque White are three slightly different white glazes. LG-11 White is white and the most opaque. DG-11 is also white, but not as opaque as LG-11. F-11 is the least opaque as well as being an off white color. They can all be used for

the Majolica technique. Apply your choice of white on a mature Cone 04 (1940°F, 1060°C) bisque. Then paint your design using GDC Gloss Decorating Colors over the unfired white glaze. Fire when your design is done. There is no need for clear glaze over the GDC design when you have white glaze as a base. Because of the opacity of the DG Deco Gloss Series, essentially any color could be used as a base to design on with the Majolica technique.

More detailed information about the GDC Series can be found on pages 23 and 24.

** All LG, F, and DG glazes are lead free except LG-9, LG-32, LG-53, LG-56, and LG-66.

APPLICATION OF LEAD CONTAINING GLAZES IN THE LG SERIES

These glazes contain fritted lead: LG-9, LG-32, and LG-36. Always read the label for safety precautions. Application and firing of these glazes is the same as discussed earlier for other gloss glazes. However, these glazes are more forgiving if underfired.

Brushing as discussed earlier is the best mode of application for these glazes.

Pouring, Sponging, and Dipping: If any of these techniques is used for lead containing glazes, we recommend using rubber gloves, so that glaze will not get on your hands and run the risk of hand to mouth contamination and ingestion of lead.

APPLICATION AND FIRING OF BRIGHT REDS AND ORANGE CADMIUM GLAZES

LG-53, LG-56, and LG-66 are lead/cadmium red glazes. Brilliant Red, Orange, and Yellow glazes belong to a family of ceramic products which are traditionally temperamental. To insure the ultimate in color development from AMACO® LG-53, LG-56, and LG-66, be very careful that these glazes are not overfired. Their limit is Cone 06 (1830°F, 999°C), preferably by cone observation. If other means of end-point measurement are used, please verify the accuracy of such devices by comparing them to cones.

This type of glaze must be applied quite heavily—about twice as thick an unfired coat as is usually necessary for more conventional glazes. These products must be applied to bisque ware that has been fired to a mature Cone 04 (1940°F, 1060°C).

An important factor in the success of these glazes is the need for a fast firing (3-4 hours) to no higher than Cone 06 (1830°F, 999°C) and their requirements of a generous air supply during firing. The kiln should be stacked with plenty of air space around the pieces to permit circulation. Do not crowd the kiln. Fire with peep holes left open during the entire firing cycle. Sometimes the door of the kiln may be left ajar, anything to assure a plentiful amount of oxygen.

Finally, the proximity of copper green glazes will adversely affect the red glazes. Pieces with green-colored glaze should be kept as far removed as possible from the red glazes. When all of these points of advice are carefully observed, we are confident that the beautiful bril-



liant results expected of AMACO® products will be achieved.

AMACO® MATT GLAZES — LEAD FREE

LM Matt series are all lead free. They can be applied easily using general application methods, of brushing, sponging, pouring and dipping.

LM glazes can be used on any of the AMACO® earthenware bodies. Careful firing is rather important for this series. Although they can be fired from Cone 05 (1915°F, 1046°C) to Cone 02 (2048°F, 1120°C), they are flat matt only at Cone 05 (1915°F, 1046°C). The higher the firing temperature, the glossier they will become. For best results, apply over bisque that has been fired to a mature Cone 04 (1940°F, 1060°C). Then, slow-fire to a witness Cone 05 (1915°F, 1046°C). The LM glazes are nonflowing when fired, therefore they are excellent for majolica decorations using the GDC colors. They also work very well in combination with other glaze series, by applying them over or under the Gloss, Lustre, or Arroya glaze series. Remember, such combination of glazes is not dinnerware safe even if all glazes used are dinnerware safe. Try these techniques only if you are doing artwork.



AMACO® ALLIGATOR GLAZES — LEAD FREE**

The LT Alligator glazes are excellent alone, as well as beautiful in combination with other glazes. Most of the LT glazes in category (3) can be applied over, under, and between other glazes for many unusual and varied effects. No two pieces glazed with AMACO® LT Alligator glazes will ever be alike. The fired result will depend upon the structure of the ware used, the thickness of application, the firing temperature, and the firing speed. Variegated matt texture predominates at the lower and slower firing temperatures and gloss textures at the higher and faster, with a mingling of matt and gloss between the extremes.

These glazes can be used over any of the AMACO® earthenware bodies. When used over AMACO® NO. 67 clay, the clay color shows through high relief areas, and contrasts or blends with the glaze color. The entire piece is enriched by the warm undertones.

LT Alligator glazes can be applied easily by following the “General Glaze Application Methods” (page 16). Remember, those glazes in category (3) in the catalog contain fritted lead, therefore take appropriate precaution for lead containing glazes (see “Safe Use of Ceramic Art Materials,” page 4) and be sure to read the label. Apply over bisque which has been fired to a mature

Cone 04 (1940°F, 1060°C). Category (1) glazes are lead free and require a more precise firing due to their short firing range. Apply over a mature Cone 04 (1940°F, 1060°C) bisque then slow-fire to Cone 05 (1915°F, 1046°C).

Jewel Brown is a dark brown and amber aventurine type of glaze with infinite depth and gold flecks appearing throughout. It should be brushed very thoroughly. Fire with good ventilation to Cone 05 (1915°F, 1046°C).

**All LT Series glazes are lead free except LT-24, LT-31, LT-115, LT-121, LT-122, LT-130, LT-133, LT-142, and LT-144.

STONE TEXTURE GLAZES — LEAD FREE

These glazes have a smooth, unique stone-like surface when fired over a Cone 04 bisque. The ST glaze series flows a little in the firing, settling in the crevices and towards the bottom of a vertical surface. Therefore, when applied over a textured surface they will produce antique-like variations or a weathered and worn out look on the higher relief areas of the piece. Because they move slightly, care should be taken to taper down the glaze application towards the bottom of the piece so that the piece will not stick to the kiln shelf during firing.

These glazes can be used over any AMACO® earthenware clay. When applied over Indian Red Clay No. 67, the clay color showing through the high relief contrasts and blends with the glaze color and the entire piece is enriched by the warm undertones.

AMACO® Stone Texture glazes are best applied over Cone 04 bisque. The recommended firing temperature is Cone 05 (1911°F, 1044°C), however they could be

fired lower to Cone 06 (1855°F, 1013°C) or higher to Cone 04 (1971°F, 1077°C) to produce different effects. Do not be afraid to experiment. AMACO® Stone Texture glazes can also be used by applying them over or under other glazes like the LG, F, or DG series or within their own series.

AMACO® OPALESCENT GLAZES — LEAD FREE

Cone 05 (1915°F, 1046°C). Although AMACO® Opalescent glazes may be used on any AMACO® clay, they develop their greatest opalescence and most interesting textures when applied over AMACO® Indian Red Clay No. 67. Most of the AMACO® Opalescent Glazes have a high gloss, with best results achieved with three or four coat applications of glaze. On textured ware, the glaze flows thin on relief and thick in incised areas, giving an added dimension on the surface.

AMACO® Opalescent Glazes can be used effectively in Raku firing. We suggest controlled experimentation with Opalescent glazes, (for example O-42, O-23 at Cone 5, 2186°F, 1196°C). When fired at this temperature on the inside of a stoneware bowl, the glaze flows to produce a variegated bottom and thins at the rim to expose more of the clay body.

AMACO® SAHARA HIGH FIRE GLAZES — LEAD FREE

These glazes are compounded to fit porcelain and stoneware bodies. Matt and textured glazes suitable for stoneware and transparent gloss glazes for translucent porcelain are included in this series.

AMACO® Sahara High Fire

Glazes work well and produce interesting effects when fired in reduction as well as in oxidation (reduction firing is not recommended for HF-26). We also suggest experimentation using Opalescent glazes or High Fire Texturizers in combination with High Fire Glazes.

Although these glazes may be applied on bone dry greenware for single firing, it is easier to apply them on low fire bisque. HF-26 and HF-32 should be applied thicker than other glazes in this series. HF-36 should be fired to Cone 4 (2167°F, 1186°C) to obtain texture. For best results: Fire over Cone 04 (1940°F, 1060°C) bisque and apply glaze by following the “General Glaze Application Methods” (page 16) and fire. Then, clay and glaze may be matured at the same time, at the recommended firing temperature of Cone 5 (2185°F, 1196°C).

A zinc-free, clear transparent high fire glaze (HF-9) is also available. Because the presence of zinc in a glaze formula may change the appearance of certain colors (green, black, gray, etc.) a zinc-free clear is very important for application over underglaze decoration. When used under HF-9 Zinc-Free Clear, colors will fire true. Any variation in color intensity of the underglazes will then depend on the individual color stability at Cone 5 (2185°F, 1196°C). Firing range of HF-9 is from Cone 4 (2167°F, 1186°C) to Cone 6 (2232°F, 1222°C).

AMACO® TH-1 AND TH-2 HIGH FIRE TEXTURIZERS

Superposition (overlying of glaze) is a very common practice among potters and is done either by brushing one glaze over another on a portion of the ceramic piece or partial dipping. When superposition

is done on part of a ceramic piece, the rest of the piece is left exposed, producing a variation in color, texture, and depth, which simulates reduction glazes in an electric kiln, while retaining a clean atmosphere and without the trouble of reducing or reaching Cone 10 (2381°F, 1305°C) temperatures.

TH-1 is a rutile base texturizer. In superposition with other glazes it tends to produce a yellowish/orange crystal-type texture. It will yield excellent results with most AMACO® HF Series glazes when applied over or under the glazes. As results vary from glaze to glaze, be sure to fire a test sample first.

TH-2 is an iron oxide base texturizer. It will have a dark brown glaze effect in most applications with texture depending on glaze combination. This texturizer will produce pleasing results when applied over or under most AMACO® HF Series Glazes. As results vary from glaze to glaze, be sure to fire a test sample first.

AMACO® UNIQUE TEXTURE GLAZES — LEAD FREE

AMACO® Unique Texture glazes have a very fine matte texture finish with a tiny gloss crystal. The crystal becomes recessed into the matte texture background during firing. These glazes do not seal the ware and finish remains porous even after firing. Because Unique Texture glazes remain porous, it is not recommended to glaze the inside of the pieces. Glaze finish will vary with firing temperature. A more glossy finish will be achieved with a hotter firing and a more matte finish will be attained with a cooler firing temperature. These glazes are opaque, therefore, one color can be applied over another for designer work. The Unique Texture glazes can be intermixed to

create new colors. This series has the same color tone before and after firing. The colors will only intensify in the firing.

AMACO® UT Glazes may be applied to greenware or a mature Cone 04 (1940°F, 1060°C) bisque. Brushing, pouring, and dipping as described in “General Glaze Application Methods” (page 18) are all suitable methods of application. Four coats of application result in more texture. Recommended firing temperature is Cone 06-05 (1830°-1915°F, 999°-1046°C). Unique Textures are not suggested for dinnerware due to the texture surface of the glaze.

AMACO® Unique Texture glazes may also be used on stoneware and porcelain. When fired to Cone 5 (2185°F, 1196°C), these glazes have a speckled, semi-gloss surface. They may be used for dinnerware surfaces only when fired to Cone 5 (2185°F, 1196°C).

AMACO® TL-1 TEXTURIZER — LEAD FREE

TL-1, when used with other Cone 05 (1915°F, 1046°C) firing glazes, creates beautiful mottling effects. TL-1 can be applied under, over, or between other glazes, to create different textures. It creates a white breakup surface and will subtly reflect the colors of the glazes with which it is used. These surface textures vary depending on the type of base glaze (gloss, matte, or textured), increasing the glaze palette tremendously. An even wider variety of effects can be achieved by applying TL-1 between coats of two different glazes.

Follow the “General Glaze Application Methods” (page 18) to apply TL-1. Fire to a mature Cone 05 (1915°F, 1046°C).



AMACO® WHITE PEBBLE

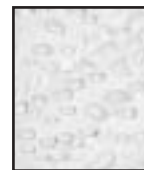

Pebble has a pebbly appearance, as it breaks up into patterns resembling pearl tapioca after firing. The break up is dependent upon the application. Pebble can be used under, over, and between the glazes for varied and interesting effects and is excellent for design work. To expand the color horizon, Pebble may be tinted with any AMACO® Liquid Underglaze or any AMACO® Velvet. We suggest wetting the ware with a sponge or brush before applying the pebble, to slow the drying and help it adhere better. Pebble is a lead containing glaze. Therefore take appropriate precautions (pages 4-6) and read and follow warnings on the label. Apply over a mature Cone 04 (1940°F, 1060°C) bisque.

Shake and stir thoroughly. To achieve a good application of Pebble, especially when using for all over coverage, load a fan brush and apply three coats to the ware in rapid succession. **DO NOT** allow to dry between coats as is the usual procedure, but apply each succeeding coat over a damp coat.

To prevent the Pebble from flaking off as it dries, apply one coat of wax resist. Fire to a witness Cone 05 (1915°F, 1046°C).

AMACO® OVERDRIFT SPECIALTY GLAZE

Overdrift is an opaque, frosty white glaze, heavy in consistency. It is indispensable in combination glaze techniques. When used in combination glaze work, Overdrift's strong white opacity partially modifies the color of the base glaze. It renders a cascade of white floats when applied over or under a glaze. It is also excellent on red clay.

Results are dependent on the method and quality of application and the firing. Consistency should be like thick cream. If thinning is necessary, add a little water and AMACO® Gum Solution. Overdrift will fire to Cone 4-6 (2167°-2232°F, 1186°-1222°C). Recommended firing temperature is Cone 06-05 (1830°-1915°F, 999°-1046°C).

Overdrift is a lead containing glaze. Therefore, take appropriate precautions (pages 4-6), read and follow warnings on the label.



**AMACO® OLD
WORLD CRACKLE
GLAZES — LEAD
FREE**

Crackle glazes are formulated to produce a network of cracks on the fired ware similar to crazing. To emphasize the crackle after firing, swab the lines with colored inks. Recommended for use on decorative items only, as it does not seal the surface of the ware as other glazes do. Apply crackle glaze over a mature Cone 04 (1940°F, 1060°C) bisque as described in the “General Glaze Application Methods” (page 17). Fire to Cone 06 (1830°F, 999°C) only, for best results. Too hot a firing will prevent the crackle. To accentuate the crackles, after firing apply a watered down Velvet, Underglaze, or India ink all over the surface of the glaze, then wipe off. The color will remain in the cracks and intensify the crackle pattern.

**AMACO®
ARROYA GLAZES —
LEAD FREE**

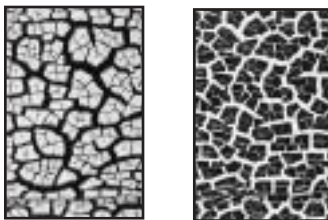

Arroya glazes are textured and produce a unique carved effect when fired. Designed for use over gloss and matte unfired glazes, Arroya glazes are best applied with a fully loaded fan blender for all-over coverage or with a sponge when using a pouncing method. The heavier the application, the larger the break-up effect and the more matte the finish.

Arroya glazes can be used in combination with other glazes, not only over, but under and between to get different interesting textures.

Recommended firing temperature is Cone 06-05 (1830°-1915°F,

999°-1046°C). However, they could be fired at higher temperatures, depending on the temperature and character of the glaze with which it is used, and the final effect that you are trying to achieve. Test fire samples when you are doing combination glazes before you do your final piece. These glazes must be applied to a mature Cone 04 (1940°F, 1060°C) bisque.

**AMACO® LUSTRE
AND METALLIC
GLAZES**

These glazes provide the metallic look of hard steel and the high brilliance of lustre. The end result is determined by the structure of the ware and the method of application. Lustre and Metallic glazes can be used effectively in conjunction with other glazes or dramatically by themselves. The Lustre and Metallic glazes can be high fired to Cone 4-6 (2167°-2232°F, 1186°-1222°C) with fantastic results.

However they are fluid at that temperature, therefore precautions in application and firing must be taken.

Apply over a mature Cone 04 (1940°F, 1060°C) bisque as described in the “General Glaze Application Methods” (page 17). Fire to witness Cone 06-05 (1830°-1915°F, 999°-1046°C). Only L-518 Lustre Gold must be applied heavier. Apply at least four coats, making sure coverage is even all over, then fire to a mature witness Cone 04 (1940°F, 1060°C).

**AMACO®
CRYSTALTEX GLAZES
— LEAD FREE****

AMACO® Crystaltex Glazes are for the potter who dares to try something novel. Multi-color effects can be subtle as with CTL-32, which fires to a creamy yellow peppered with rich brown, or they can be flashy and gay like the red, white and blue of CTL-54 Firecracker. No two pieces will ever be alike, but all will be unique.

These liquid glazes consist of a basic color with the addition of one or more crystals of contrasting colors. For application by dipping or pouring, it is necessary to thoroughly stir the glaze since the crystals settle to the bottom of the jar. A more controlled decorative effect is obtained by brushing. The brush is dipped in the glaze at the top of the jar and two or more coats applied. Then the crystals, which will have settled to the bottom are lifted with the brush or screened through a sieve and placed where desired. Crystals fan out on horizontal surfaces and run on vertical pieces. Best results are obtained at Cone 05 (1915°F, 1046°C). These glazes must be applied to mature Cone 04 (1940°F, 1060°C) bisque and glaze fired to Cone 05 (1915°F, 1046°C).

** All CTL Series glazes are lead free except CTL-33, CTL-50, and

AMACO® LIQUID UNDERGLAZE TEMPERATURE/COLOR VARIATION CHART

The AMACO® color chart between pages 22 and 23 shows the AMACO® LUG series fired to Cone 05. The variations listed below will occur when these glazes are fired to Cone 5 and 10.

	Cone 5 Glazed With HF-9	Cone 10 Glazed With HF-9
LUG-1	Black	Black
LUG-10	White	White
LUG-15	Gray	Gray
LUG-20	Light Blue	Turquoise Blue
LUG-21	Medium Blue	Medium Blue
LUG-22	Dark Blue	Dark Blue
LUG-25	Turquoise	Turquoise
LUG-26	Dark Aqua	Green
LUG-30	Light Brown (rough surface)	Light Brown (rough surface)
LUG-31	Mahogany Brown	Mahogany Brown
LUG-40	Chartreuse	Pale Green
LUG-42	Dark Blue Green	Dark Blue Green
LUG-43	Dark Green	Dark Green
LUG-50	Pink	Pink
LUG-51	Irregular Washed Out Rose	Dirty White
LUG-52	Very Light Beige	Very Light Beige
LUG-53	Sun Tan	Dark Sun Tan
LUG-54	Light Lilac	Irregular Washed Out Lilac
LUG-55	Washed Out Medium Blue	Washed Out Dark Blue
LUG-56	Irregular Rose	Dirty Pale Rose
LUG-60	Light Yellow	Greenish Yellow
LUG-61	Bright Yellow	Greenish Bright Yellow
LUG-65	Tan Brown	Light Tan Brown

CTL-54. Take appropriate precaution when using lead containing glazes (see "Safe Use of Ceramic Art Materials," pages 4-6) and make sure to read and follow the label.

AMACO® LIQUID UNDERGLAZE DECORATING COLORS — LEAD FREE

These concentrated, opaque colors are recommended for covering large areas quickly, easily, and smoothly. Results

are equally effective when the colors are used for detailed painting, sgraffito decoration, water color effects, free brush painting, wax resists, and mishima decoration. Twenty-four intense colors are available and other colors, shades and tints are made by blending. The colors may be brushed on greenware which is to be bisque fired before applying a covering glaze, or onto mature Cone 04 (1940°F, 1060°C) bisque, then covering glaze applied and fired to maturing temperature of the clear glaze.

For opaque coverage by brush-

ing, the consistency of the color in the jar is correct. White slip may be tinted by adding small amounts of most LUG colors to produce colored slip. Intensity depends on quantity used. To color moist clay, cut clay in very thin slices, pour LUG color between slices and wedge until uniform color is achieved.

Since the colors are approximately the same tone before and after firing, the effectiveness of color combinations and blending is observed as the painting progresses.

SELECTING TRANSPARENT COVERING GLAZES

Transparent covering glazes are applied on decorated bisque shapes, and the pieces are fired to the maturing temperature of the glaze. AMACO® glazes LG-9, LG-10, F-10, and HF-9 are recommended as clear glazes. Colored transparent glazes in the LG, F, and HF series may also be selected for unusual effects.

AMACO® liquid underglazes have only been tested and approved as dinnerware safe when applied and fired under AMACO® LG-10 Clear Glaze. Other glazes may also be used. If other glazes are used over the liquid underglazes, finished ware must be tested to establish dinnerware status.

AMACO® SUN STROKES BRILLIANT UNDERGLAZE COLORS

Vivid reds, oranges, yellow, and green! Six intense special underglazes specifically formulated for Cone 06-05 (1830°-1915°F, 999°-1046°C) in oxidation and Raku firings, with or without a clear glaze. Clear glaze smoothes out

and brightens the colors. Apply two even coats to bisque only. They can be used also for shading, detailing, and brushwork. When using clear glaze, it must be applied over the decorated object **BEFORE** firing of the underglaze. No. SP-10 Clear Transparent has been developed for use in conjunction with these underglaze colors for one stroke application. For all over coverage of the Sun Stroke underglazes, any lead containing clear glaze may be substituted with excellent results. Apply one even coat on mature Cone 04 (1940°F, 1060°C) bisque. Fire to Cone 06-05 (1830°-1915°F, 999°-1046°C).

Sun Strokes Underglazes have only been tested and approved as dinnerware safe when applied and fired under SP-10. If other glazes are used over Sun Strokes Underglazes, finished ware must be tested to establish dinnerware status.

AMACO® GLOSS DECORATING COLORS FOR BISQUE AND MAJOLICA — LEAD FREE

Bisque Underglazes, One Step Method

The GDC Series is very versatile. Colors can be used directly over Cone 04 bisque to create a design, then clear glazed and fired. This is a one step method, where there is no need to fire the GDC before applying the Clear Glaze. However Clear Glaze should be applied by dipping using AMACO® DC-10 Dipping Glaze or by sponging, using either LG-9 or LG-10. When using GDC colors on bisque, they can be applied in one coat to create translucent designs or apply two or three coats for a more solid color.

Majolica

Cone 05. The Gloss Decorating Colors (GDC) were developed specifically to produce the Majolica technique. Each of these colors can be applied directly over unfired LEAD FREE AMACO® LG-11 Opaque White glaze. The special formulation of this exciting 36 color series means that no clear covering glaze is necessary. Colors will fire glossy and assume the smooth surface of the white base glaze. Recommended firing temperature is Cone 05 (1911°F, 1044°C). The colors in the GDC series have only been tested and approved as safe for dinnerware when applied alone and on top of AMACO® LG-11. They must be retested as safe for dinnerware if they are used on top of other glazes.

These colors will also produce excellent results when used over most of the AMACO® LG Series Glazes as well as the F, LM and the DG Series glazes.

The GDC colors can be successfully used over other white or color glazes as long as a small sample is pretested first to establish the appropriate temperature to achieve the best results. Variations on how the GDC series can be used is limited only to the potter's imagination.

All-Over Coverage

The Gloss Decorating Colors can also be used for over all coverage or to design over the bisque with no additional glaze over or under it. In such cases, application should be of at least two coats or more to achieve good results.

High Fire Majolica Technique

When GDC colors are used for stoneware, use HF-11 White glaze over bisque and follow the same decorating tech-

nique as earthenware. Glaze fire to Cone 5 (2205°F, 1207°C). Colors will not change at Cone 5 except the following: GDC-55 will change to Dark Blue, GDC-45 will change to Dark Green, and GDC-64 will change to Light Yellow/Green.

AMACO® VELVET UNDERGLAZES — LEAD FREE

AMACO® Velvets, a semi-translucent underglaze, offer two finish possibilities. When left unglazed they have the appearance of velvet or velour. They will assume a soft satin matte finish when glazed with AMACO® Transparent Matt glaze and will intensify in color when covered with an AMACO® Clear Transparent Gloss glaze.

Red and Violet Velvets 380 through 384 have a unique formula that makes them very versatile. They can be used in detailed design work as a Cone 05-06 (1915°-1830°F, 1046°-999°C) underglaze or they can be fired up to Cone 6 (2232°F, 1222°C) and maintain their intensity and brightness. All the Velvets are very rich colors and can be used for an all over coverage similar to an opaque underglaze. They fire true to color as applied from the jar and may be intermixed to create a palette of hundreds of colors.

The colors may be brushed on greenware which is to be bisque fired before applying a covering glaze or onto a mature Cone 04 (1940°F, 1060°C) bisque, then a covering glaze is applied. When applying over bisque, make sure to apply thin coats and let each coat dry before applying the next. It is preferable not to apply Velvets very thick over bisque. For opaque coverage by brushing, the consistency of the color in the jar is correct.

Velvets tolerate a wide firing range with recommended firing temperature being that of the clay used.

NOTE: V-317 Medium Pink

will change color and blister at Cone 5 (2185°F, 1196°C).

Velvets were developed to be used without a glaze cover. They should not be used on surfaces which come into contact with food or drink. AMACO® glazes LG-9, LG-10, F10, and HF-9 are recommended as clear glazes over Velvets. AMACO® Velvet Underglazes have only been tested and approved as dinnerware safe when applied and fired under LG-10 Clear Glaze. Other glazes may be used over the Velvets, however the finished ware must be tested to establish dinnerware status.

AMACO® VELVET-1-STROKES — LEAD FREE

Velvet-1-Strokes are as versatile as the original Velvet Underglazes. They are premixed and ready to use right from the jar. They can also be glazed over with a transparent or translucent glaze or left unglazed for that beautiful velvet finish. Velvet-1-Strokes have a wide firing range from Cone 05 (1915°F, 1046°C) for earthenware to Cone 6 (2232°F, 1222°C) for stoneware or porcelain. They have a high concentration of color and are excellent for detail and one stroke designs.

Velvet-1-Strokes should not be used on surfaces which come in contact with food or drink. AMACO® glazes LG-9, LG-10, F-10, and HF-9 are recommended as clear glazes over Velvet-1-Strokes. Velvet-1-Strokes may be brushed on greenware which is to be bisque fired before applying a covering glaze or applied to a mature Cone 04 (1940°F, 1060°C) bisque, then a covering glaze is applied. For application on bisque, follow bisque application directions of Velvets. For opaque coverage by brushing, the consistency of the color from the jar is correct.

AMACO® Velvet-1-Strokes have only been tested and approved as dinnerware safe when applied and fired under AMACO® LG-10 Clear Glaze. Other glazes may also be used over the Velvet-1-Strokes, however the finished ware must be tested to establish dinnerware status.

AMACO® DESIGNER VELVET UNDERGLAZES — LEAD FREE

Designer Velvets are semi-translucent underglazes that have the same distinction as the original Velvets with one difference: they have small specks in them. When left unglazed, they assume the appearance of velvet or velour with a soft speckle effect. When glazed with AMACO® Transparent Matte or Clear Glazes, they slightly intensify in color. Designer Velvet colors can be used on greenware or bisque. For application on bisque follow bisque application directions of Velvets. All colors are lead free. Recommended bisque firing range is Cone 04 (1940°F, 1060°C), but Designer Velvets tolerate a wide firing range with recommended firing temperature being that of the clay used.

To prepare these underglazes, shake and stir for thorough mixing. It is usually not necessary to thin these colors. However, upon occasion or for varying techniques, it may become necessary to thin Designer Velvets. In this case add a few drops of water and mix thoroughly.

Apply the same as you do Velvets. Designer Velvets have the same characteristics.

**AMACO®
SEMI-MOIST & TUBE
UNDERGLAZE
DECORATING COLORS
— LEAD FREE**

AMACO® Semi-Moist and Tube Underglaze Decorating Colors are suitable for many types of ceramic painting. They are especially good for water color effects and painting in fine detail.

Thirty-two intense decorating colors are concentrated and opaque. Additional shades and tints are made by intermixing. Colors may be brushed on either bisque or greenware. A brush dipped in water lifts the color for decorating. Further thinning of the water soluble colors prepares them for transparent water color effects by brushing. Tube Underglaze Colors are the correct consistency for silk screen printing.

Because the colors are approximately the same tone before and after firing, the effectiveness of color combinations and blending can be observed as painting progresses. Colors dry quickly and may be handled without damage.

For clear, covering glazes, AMACO® LG-9, LG-10, F-10, and HF-9 are recommended. They will not discolor the underglaze decoration or cause the colors to bleed.

If the clear, transparent covering glaze is to be applied on the decorated bisque by brushing, dab the first coat with a sponge or brush. Let dry and then brush on the next two coats. When the underglaze colors are applied on greenware, they are hardened on the bisque firing which must be done to a mature Cone 04 (1940°F, 1060°C) and then the covering glaze applied either by brushing or sponging. Pieces are fired to the maturing temperature of the covering glaze. Pink,

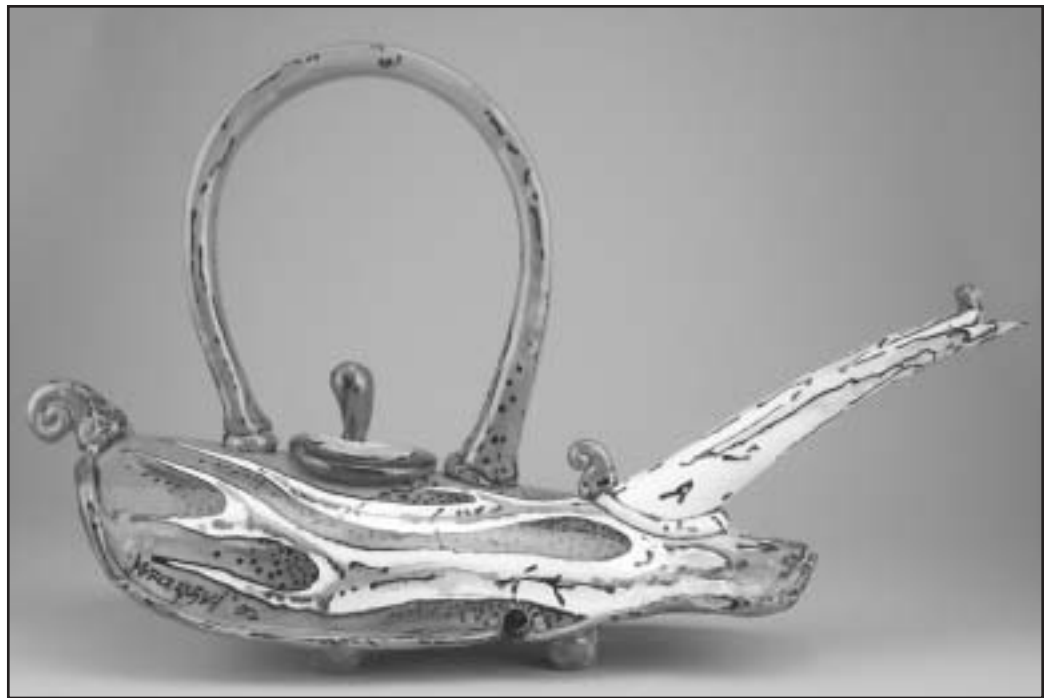

Maroon, Peach, Rose and Yellow hold their color when fired to temperatures up to Cone 6 (2232°F, 1222°C). All other colors may be fired to an upper limit of Cone 10 (2381°F, 1305°C) with good retention.

**AMACO®
UNDERGLAZE
DECORATING
CHALK CRAYONS —
LEAD FREE**

Pastel Techniques. Ceramic decoration with unusual, effective style and a variety of textures is created with AMACO® Underglaze Decorating Chalk Crayons. The 2²/₃" x 7¹/₁₆" chalk crayons are made in sixteen colors ranging from intense hues to pastel tones. On bisque pottery they are used like pastels.

Sketching on bisque with AMACO® Underglaze Chalk Crayons results in pebbled appearances.

Colors may be blended or smoothed by rubbing with the fingers or a cotton swab. Water color effects are obtained by brushing sketches with water. For

fine lines, the chalk crayons can be sharpened. Small pieces of chalk crayon may be dissolved in water for painting.

Selecting a Covering Glaze. Clear Transparent AMACO® Glazes LG-9, LG-10, F-10, and HF-9 are recommended. Sponge on first coat of clear glaze lightly in order not to smear design. Let dry and brush on two additional coats of clear transparent AMACO® glaze. This precaution is unnecessary if the glaze is to be applied by spraying, dipping, or pouring. Pieces are fired to the maturing temperature of the covering glaze. When spray application of a covering glaze is desired, first refer to individual listing to be sure that it may be sprayed safely.

**AMACO®
UNDERGLAZE
DECORATING
PENCILS —
LEAD FREE**

Now more intense, with better working qualities, Underglaze Decorating Pencils are ideal for shading, fine line drawing or iden-

tification. Apply the underglaze pencil to bisque to create a variety of unique decorative designs. After decorating, dust lightly with a brush to remove excess particles.

Sponge on first coat of clear glaze lightly in order not to smear design. Let dry and brush two additional coats of clear transparent AMACO® glaze. This precaution is unnecessary if the glaze is to be applied by spraying, dipping, or pouring. Pieces are fired to the maturing temperature of the covering glaze. When spray application of a covering glaze is desired, first refer to individual listing to be sure that it may be sprayed safely.

A set of all six colors comes in handy vinyl pouch. Blue, Green, and Black will maintain color intensity up to Cone 10 (2381°F, 1305°C) temperature, Cone 5 (2185°F, 1196°C) for all other colors. Color intensity may vary at Cone 5 (2185°F, 1196°C) and above on all colors.

**AMACO® ENGObES
— LEAD FREE**

Sgraffito, Slip Trailing, and Painting. Engobes are either natural clays

VELVETS TEMPERATURE/COLOR VARIATIONS CHART

The AMACO® color chart between pages 22 and 23 shows the AMACO® Velvet series fired to Cone 05. The variations listed below will occur when these underglazes are fired to Cones 5 and 10.

Cone-5		Cone-10	
Unglazed	Glazed with HF-9	Unglazed	Glazed with HF-9
V-301	Light Ivory	Light Ivory	Light Buff
V-302	Light Dusty Beige	Dark Dusty Beige	Warm Light Beige
V-303	Light Terra Cotta	Light Olive Green	Light Brown
V-304	Yellow/Tan Flesh	Textured Light Beige	Light Yellow/Beige
V-308	Bright Yellow	Bright Yellow	Pale Yellow
V-309	Orange/Yellow	Tan	Orange/Tan
V-310	Dark Tan	Bright Dark Tan	Dark Tan
V-313	Dark Red Brown	Bright Red Brown	Dark Satin Brown
V-314	Chocolate Brown	Chocolate Brown	Satin Black Brown
V-315	Dark Peach	Dark Peach	Yellow/Peach
V-316	Dark Pink	Pink	Dark Pink
V-317	Not Recommended	Not Recommended	Not Recommended
V-318	Glossy Rose	Rose	Very Pale Lilac
V-320	Light Blue Violet	Blue Violet	Pale Dirty Violet
V-321	Orchid	Deep Orchid	Pale Dirty Lilac
V-322	Deep Purple	Deep Purple	Dark Gray
V-323	Salmon	Salmon	Salmon
V-325	Satin Baby Blue	Light Blue	Gloss Light Blue
V-326	Rich Electric Blue	Ultramarine Blue	Satin Rich Blue
V-327	Deep Turquoise	Deep Turquoise	Deep Turquoise
V-328	Gray	Gray	Light Gray
V-332	Dark Blue	Dark Blue	Dark Blue
V-333	Dark Avocado	Light Brown	Dark Avocado
V-334	Satin Flaxen	Flaxen	Gloss Ivory Beige
V-336	Glossy Dark Blue	Dark Blue	Metallic Dark Blue
V-341	Dark Blue Green	Dark Blue Green	Dark Blue Green
V-343	Chartreuse	Chartreuse	Victoria Green
V-345	Dark Green	Dirty Light Brown	Satin Green Black
V-350	Satin Beige	Beige	Satin Beige
V-353	Dark Green	Dark Green	Dark Green
V-354	Dark Green	Dark Green	Metallic Green Black
V-355	Greenish Black	Greenish Black	Black
V-356	Dark Gray	Dark Gray	Light Gray
V-357	Deep Olive Green	Deep Olive Green	Deep Green
V-360	White	White	White
V-361	Intense Black	Intense Black	Intense Black
V-366	Bright Medium Brown	Bright Medium Brown	Medium Brown
V-367	Mist Gray	Mist Gray	Mist Gray
V-368	Antique Ivory	Antique Ivory	Ivory
V-369	Dark Fawn	Dark Fawn	Fawn
V-370	Black	Black	Black
V-371	Mauve	Light Mauve	Yellowish White
V-372	Misty Light Green	Gray	Gray
V-373	Medium Brown	Medium Brown	Golden Brown
V-374	Royal Peach	Royal Peach	Soft Light Peach
V-375	Faded Maroon	Dusty Light Pink	Faded Rose
V-376	Green	Green	Intense Green
V-380	Violet	Violet	Light Violet
V-381	Bright Purple	Bright Purple	Bright Purple
V-382	Red	Red	Red
V-383	Light Red	Light Red	Light Red
V-384	Real Orange	Real Orange	Real Orange
V-385	Chocolate Brown	Chocolate Brown	Metallic Gray
V-386	Royal Blue	Royal Blue	Intense Blue

or a mixture of clays and ceramic raw materials, and are typically rich earth colors and subdued tones. Only water is added to obtain a working consistency like thick cream.

Methods of Decoration. Engobes may be brushed, poured or trailed thinly on wet or dry greenware. Sometimes they are used to cover an inferior body, but generally are applied as decoration to contrast with the color of the clay piece. Slip painting, slip trailing and Sgraffito are especially good decorating methods for engobes. For best results when slip painting, mix to a thin consistency and use short brush strokes. The designs should be compressed with direct strokes of the brush which is heavily loaded with the engobe. More elaborate designs may be made by the slip trailing method. Try decorating with the AMACO® Slip Trailer to produce thin and thick line designs. When the sgraffito process is used, designs are scratched into a layer of engobe so that the color of the clay shows through.

Any AMACO® dry or moist pottery may be decorated with AMACO® Engobes and fired to the maturing temperature of the basic clay. Usually a clear transparent glaze for unique effects is applied over the entire decorated shape.

AMACO® SEMI-MOIST OVERGLAZE DECORATING COLORS

AMACO® Semi-Moist Overglaze Decorating Colors are permanent ceramic decoration for pottery and metal enameled pieces. Tiles, sculpture, costume jewelry and commemorative plates are only a few of the many items suitable for brilliant overglaze decoration.

The water soluble colors may be intermixed to obtain many colors,

shades and tints. Put a few drops of water in the pan, let it sit for 5 to 10 minutes, then, a brush dipped in the pan lifts the intense, semi-moist color from the pan for application on glazed pottery or fired enamel surfaces. There is no waste. Colors dry quickly and are practically the same tone before and after firing.

Decorated pottery is fired to Cone 018 (1323°F, 717°C).

DO NOT use overglaze decorating colors on dinnerware surfaces unless it is pretested for lead release.

AMACO® WB-SERIES VERSA COLOR — LEAD FREE

AMACO's WB Series of Versa Color is a lead free series of eight colors in a convenient waterbase for application onto lead free glazes. This series attain the same beautiful fired results as the original lead containing series.

These easy-to-use, economical overglazes have a consistency suitable for silk screen printing, stencil, and free brush decorating methods, as well as china painting. Colors may be thinned with water. They do not have the unpleasant odor of oil based products, and brushes may be cleaned with water. Color blending is easy; most colors can be intermixed in all proportions for additional variety. The gold containing color, WB-56 Red, when mixed with other basic colors should be done with the maximum proportion of gold containing colors in the mix, in order to maintain the stability of the fired color. After painting your design do not wait for WB Versa Color or Opalescents to dry. They will not dry. Just handle carefully without touching your design and fire immediately.

Recommended firing temperature is Cone 018 to Cone 015 (1337°-1485°F, 725°-807°C). For best results when using WB-56 Red, fire to Cone



016 (1443°F, 784°C) in 4 hours, then soak at Cone 016 (1443°F, 784°C) for at least 4 hours. A thin application will improve brightness.

WB-Series Versa Color are semi-opaque with a brilliant sheen. The greatest contrast is obtained when applied on a white glazed background. Less color contrast but interesting results are obtained on colored clays and glazes. When applied over matt glazes or on vitrified bisque, they have a matte finish. A 200 mesh screen is recommended for silk screening.

AMACO® WATER-BASE OPALESCENT — LEAD FREE

These eight intermixable colors provide a new aspect of lustrous finishes, compared with the pure gloss surface of the other Versa Color. They are opaque and the opalescent lustre appears three dimensional and seems to come from the depth

of the decorated object.

The WB-Opalescent Series becomes very glossy or changes color when fired to Cone 016 (1443°F, 784°C) and above, thus losing the lustrous opalescent effect.

When applied over dark colored glazes, they appear to intensify and their color is richer. These colors were developed to be used on lead free glazes. However, when used on a decorative item on a leaded glaze, Gold, Emerald, and Ruby become brighter. A 170 mesh screen is recommended for silk screening. Water Base Versa Color cannot be used to produce decals. It can be screen printed directly onto a flat surface (i.e. a tile). Use only Oil Base Versa Color to make decals. **DO NOT** use Versa Color on dinnerware surfaces unless it is pretested for lead release.

AMACO® OB-SERIES VERSA COLOR

OB Series Versa Color are ceramic overglaze decorating

AMACO® CERAMIC SPECIALTY PRODUCTS

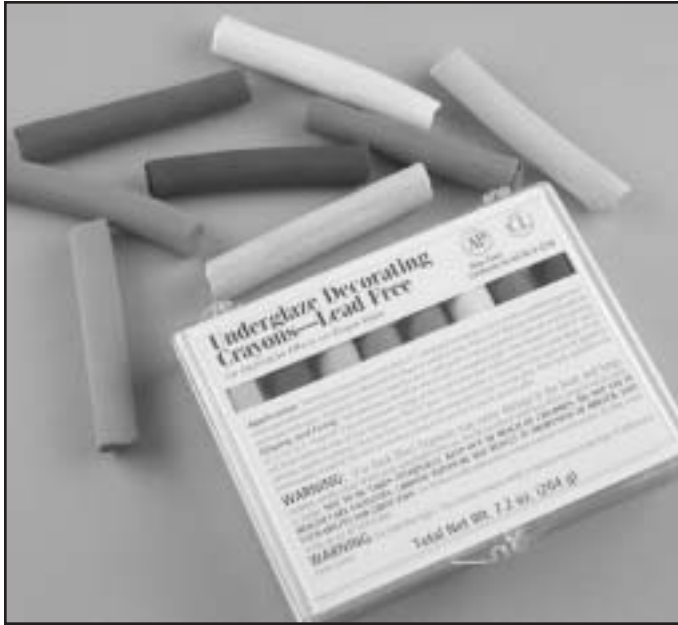

colors, finely ground in an oil base. Although developed especially for silk screen printing on glazed tiles, they are a versatile medium for all glazed pottery, sculpture, china painting, and fired metal enamel surfaces. OB Series Versa Color are an excellent product for making decals (see Custom Decal Factory in AMACO® ceramic catalog).

The eight colors may be inter-mixed for additional variety. Red, Orange, and Yellow may be mixed together, but not with the rest of the series.

The consistency of OB-Series Versa Color makes them best suited for silk screen printing, however they can also be used for stencil and free brush methods when thinned with turpentine.

When fired to Cone 018-016 (1323°-1458°F, 717°-792°C), OB-Series Versa Color are semi-opaque with a brilliant sheen. For best results fire slow. Not faster than four hours from beginning to the end of the firing. The greatest contrast is obtained when applied on a white glaze background. Less color contrast but interesting results are obtained on colored clays and glazes. When applied over matte glazes or vitrified bisque, they

have a matte texture.

DO NOT use Versa Color on dinnerware surfaces unless it is pretested for lead release.

AMACO® GLASS & METAL ENAMEL CERAMIC DECORATING COLORS

When applied on glassware and fired metal enamel surfaces, AMACO® Glass and Metal Enamel Decorating Colors result in colorful decoration that is permanent and washable.

Put a few drops of water in the pan to soften the semi moist colors, then dip brush to lift the color, or you can dilute them like an ink and dip a pen to pick up color and write on the glass or prefired enamel surface.

Decorated glassware is placed in a cool kiln, and fired slowly to 1121°F (605°C). Decorated enamel pieces are placed in a preheated kiln and fired for approximately 1½ minutes at 1300°F (704°C). Do not use Glass and Metal Enamel Colors on dinnerware surfaces.

AMACO® KILN CEMENT

Cracks and chips in kiln refractory can be permanently sealed with AMACO® Kiln Cement. Mix water with the dry cement for a smooth, plastic consistency. The prepared cement is ready for immediate use. When mixed with coarse grog or pieces of refractory, cement may be used to repair large holes in firebrick. To apply: Moisten the area of brick that you want to cement, then apply the premixed cement. **WARNING:** Do not allow direct contact with elements and electrical wiring.

sponge, then apply three thin coats, waiting between coats until the moisture sheen disappears. **DO NOT COAT REFRACTORY BRICKS WITH KILN WASH.** After multiple firings kiln wash will start chipping off in areas. Scrape off with a spatula or chisel and reapply.

AMACO® KILN SEAL

AMACO® Kiln Seal is ready for brushing on inside lids of top loading kilns. A thin wash prevents refractory particles from dusting off on ware during firing.

AMACO® KILN WASH

Kiln Wash is used to coat all shelves during a glaze firing. With a 1/16" thickness, life of shelves is prolonged and glaze drippings are easy to remove. Mix Kiln Wash with water to a thin cream consistency when stirred. First wet the refractory shelf with a brush or

AMACO® POTTERY PLASTER

This is a finely pulverized, highly absorbent white pottery plaster for casting, original models and especially for making molds for slip casting. For best mixing ratio use two pints of water to three pounds of Plaster. This will pro-





duce a strong enough mix and yet is absorbent enough for ceramic castings. This mix will produce an 80 cubic inch mold. If you need a more absorbent mold increase the water ratio, if you need a tighter less absorbent mold reverse the ratio and increase the plaster. Always prepare the water in the mixing container first and then add the plaster, mix until well dispersed. Wait a few minutes then pour into the form you have prepared to cast.

To calculate how much plaster to use for a certain mold, multiply the molds width times length times height in inches. Divide that by 80, to give you the number of quarts of water needed to make your size mold. Then for each quart of water use three pounds of Plaster.

AMACO® SETSTONE

AMACO® Setstone is supplied in powder form to be mixed with water. Although white Setstone is similar to plaster in working qualities, molds, castings and models are less absorbent and three to four times harder. AMACO® Setstone is recommended especially for making original models and for casting rubber molds. To prepare a mold with Setstone, use the same procedure, used in preparing plaster.

AMACOTE

Ready-to-use AMACOTE is brushed on the backs of metal shapes before enameling the other side. A coating of Amacote prevents the formation of black scale on bare metal caused by oxidation during firing. Amacote is removed easily from fired pieces.

AMACO® RUBBER LATEX

From rubber latex molds, castings can be made quickly and accurately in plaster of paris or AMACO® Setstone. The white, liquid rubber latex is applied over original models. Completed molds are tough, flexible and will often withstand 200 to 300 castings. To make a Rubber latex mold use an appropriate size brush for your project. Paint on a thin coat of Rubber Latex, wait for each coat to dry before applying the next. Up to ten to fifteen coats are needed in order to have enough mold thickness. Be careful not to let the Rubber Latex pool into crevices of the master that you are applying it on, for they will not dry. Wipe off any excess Rubber Latex as you are applying it. Since Rubber Latex molds are pliable, they can be distorted when you pour plaster into them. To prevent this from happen-

ing while you still have the Rubber Latex mold on your Master and after it has completely dried, pour plaster or apply it with a spatula to make a support backing for the Rubber mold. This will keep it sturdy when you cast into the Rubber. Rubber Latex can be thinned with water.

Besides making molds, Rubber Latex can be used as a resist for glazes. Thin down with water, then brush the design on greenware, bisque, or over another glaze or underglaze. Apply the glaze all over. When dry, peel off the Rubber Latex design and you will expose the background. Rubber Latex may cause allergic reactions so be sure to read the label before using.

AMACO® WAX RESIST

This wax emulsion, applied on greenware or bisque as a method of decoration, "resists" application of glaze, slip and underglaze.

AMACO® SP-MENDER — LEAD FREE

AMACO® SP-Mender is easy to use and provides a strong bond for mending ceramic greenware. For mending broken greenware, moisten the broken areas with water and follow with an application of AMACO® SP-Mender, press together and hold in place for a few seconds until the break is sealed and holding firmly. AMACO® SP-Mender is also excellent for stick-on-work (i.e. arms, lace, flowers, etc.).

AMACO® PLASTER SEPARATOR

AMACO® Plaster Separator is used for sizing an original model made of Setstone, plaster or any other porous material. Also, it is

used to size molds when casting reproductions in plaster or Setstone. Although brushing is the usual method of application, AMACO® Plaster Separator may be applied by dipping or pouring.

When applying make sure Plaster Separator does not pool in the crevices if you have a three dimensional design. Brush it off so the piece is coated evenly.

AMACO® N BRAND SODIUM SILICATE

AMACO® Sodium Silicate can be used with AMACO® White Art Clay 25-D and DS-225 clay as a deflocculant for making casting slip. Complete instructions are supplied on the jar.

AMACO® GUM SOLUTION

Gum may be added to correct or improve brushability of a glaze. Old dry glaze can be restored by adding a few drops of water and Gum Solution. If you have added too much water to a glaze and made it too hard to brush, add a few drops as needed of Gum Solution to restore brushability. Gum Solution is also used in metal enameling. Mix a solution of one tablespoon Gum Solution to one pint of water. Spray on metal then sift metal enamel over it. You may reapply to hold the enamel better on the metal.

GENESIS® ARTIST COLORS



THE WORLD'S ONLY HEAT-SET OIL PAINT

Genesis® Artist Colors are a non-toxic, odorless artist's paint that's unlike any other paint available. Instead of air drying like most acrylic and oil paints, Genesis® Artist Colors have a heat-fixing agent in their formula that allows them to dry in just a few minutes when heated to 265°F (130°C).

Why a heat-set paint?

- Genesis® paints are always immediately ready for use with virtually no preparation needed;
- No clean-up time is needed since the paint will not dry on brushes, palette, mixing tray or in jars;

- No set-up time is needed—colors, brushes, and painting are ready to go just as you left them;
- More time to paint;
- No waste—paint in a jar allows every drop of paint to be used and paint on the palette stays fresh;
- Mistakes are easily correctable using a soft cloth;
- The artist can work at his or her own pace – no rush to finish a painting before it starts to dry as with acrylics;
- You control the medium—the medium doesn't control you!

Genesis® Artist Colors are created in a special manufacturing process that blends the carrying medium with the powdered pigments to produce their smooth,

buttery texture. They have the feel and application of oil paints without the drying time. Their texture makes color blending easy as well as being ideal for classical glazing techniques. Custom-blended colors can be kept in their own jars without fear of drying out as well.

Genesis® Artist Colors can be applied with a brush or palette knife and can be thinned for gouache. Multi-layered paintings can be completed in a day by drying each color after it is applied. Genesis® Artist Colors allow the artist's creative inspiration to flow uninterrupted by eliminating time-consuming set-up, waiting time, and clean-up procedures required with other mediums.

The colors in the Genesis® Artist Colors palette are organized in a logical color value system. In addition, they are very lightfast. 73 of the 83 colors have a I lightfast rating and 10 are rated II.

Genesis Mediums are non-toxic, odorless and non-solvent based and alter the flow characteristics of Genesis® Artist Colors without loss of color depth. Genesis® Thinning Medium is used to thin the paints. Genesis® Glazing Medium can be tinted with Genesis® Artist Colors and applied as a very transparent glazing color. Genesis® Thick Medium functions as a color extender and can be used for impasto painting. It can also be

used as a “base” for creating new individual colors.

Genesis® Varnishes are available in three formulas: Air-Dry Removable, Heat-Set Permanent Matte, and Heat-Set Permanent Satin. The two heat-set varnishes are non-toxic and create either a matte or satin surface when applied over a heat-set Genesis® painting. They are also ideal for use as a top coat sealant over a Gicleé (water-based inkjet media). The air-dry removable varnish is applied over a heat-set Genesis® painting and allowed to air dry. This varnish can later be removed by wiping it off with an ammonia solution or window cleaner if the painting gets dirty over time.

Genesis® Air Dry Acrylic Gesso is non-toxic and the perfect base primer for Genesis® Artist Colors. It produces a flexible film with excellent adhesion that is water and UV resistant. Genesis® Brush Cleaner can be used by pouring over the bristles of the brush allowing it to penetrate all the way to the ferrule to dissolve any paint. Rinse with water for a perfectly clean brush. Brushes used exclusively with Genesis® Artist Colors need not be cleaned between uses. Leaving Genesis® Artist Colors on brushes actually acts as a nice brush conditioner. When painting is finished, brushes can be cleaned with dish soap and water, or 90% rubbing alcohol solution.

AMACO® ART AND CRAFT PRODUCTS



PERMOPLAST® MODELING CLAY —

Our Premium Quality Clay

This non-toxic clay comes in eight bright colors and is perfect for use in every grade from kindergarten through high school. For small children, Permoplast® helps develop small motor skills and hand/eye coordination. Older students will find that working with clay encourages their creativity and imagination. At the adult level, Permoplast® is very useful to clay animators, stylists and hobbyists. Cream is specially formulated for industrial use in making molds. This clay does not contain sulfur, so it is recommended for use in the making of rubber molds.

AMACO® PLAST-I-CLAY® MODELING CLAY

A Non-Toxic, non-hardening plastic modeling clay at an economical price. Plast-i-clay® helps children learn and grow by encouraging creativity and self-expression. It's clean, safe, and ideal for children of all ages. Available in six bright colors and assortments. Plast-i-clay® is easy to work with, stays soft and pliable when stored in a plastic bag, and can be used over and over. Colors can be blended together to create new ones if desired.

MEXICAN POTTERY CLAY™

Self-hardening. Objects modeled of Mexican Pottery Clay™ are a rich red color similar to Mexican or Indian Pottery, and little or no decoration is necessary. Supplied in moist form ready to use. May be shaped by hand or thrown on a wheel. When dry, modeled objects are hard and durable, without kiln or oven firing, but not waterproof. Decorate with Rub 'n Buff® or other finishes. Finished pieces can be made water resistant by coating with AMACO® Antique Bronze Finishing Glaze.

MARBLEX™

Self-hardening. Modeled objects are permanent without firing. A gray clay, Marblex™ is prepared in moist form and ready for use. Air-dried pieces are hard and durable, but not waterproof. Decorate with Rub 'n Buff® or other finishes.

Pieces made with Marblex™ can be sealed with AMACO® Antique Bronze Finishing Glaze. Let the piece dry completely before coating it entirely from all sides, in and out, to give it durability. After the glaze is completely dry, it will hold water. However, do not use for surfaces that come in contact with food or drink. Use only for decorative items.

STONEX™

Self-hardening. This white modeling clay is prepared in moist form, ready to use for all methods of modeling including wheel throwing and sculpting. When completely dry, finished pieces are durable but not waterproof. Knead Stonex™ to increase plasticity before modeling. Keep unused clay in a plastic bag or wrapped in damp cloth to prevent drying out. It will shrink during drying, so it is best to hollow out bulky sculptures or wrap a slab of clay around a loose crumpled paper armature before modeling.

Allow the finished piece to dry slowly and evenly on all sides at room temperature and away from heat until hard. When piece is completely dry, decorate with AMACO® Rub 'n Buff®, school paints, temperas, acrylics or liquid crayons. After decorating, it is a good idea to coat with shellac or varnish to seal it and make it water resistant.

MAGIC MUD

This non-toxic, non-staining, air-dry natural clay is fun to use and reusable! Developed by a classroom teacher, Magic Mud promotes endless learning, encourages unlimited discovery,

increases sensory motor development, and allows self-expression. Air-dried objects made with Magic Mud can be turned back into mud again by just adding water! Air-dried objects can also be fired in a ceramic kiln to Cone 05 (1911°F, 1044°C) to achieve maximum hardness and strength.



CRAFT PORCELAIN MODELING MATERIAL

Craft Porcelain is a pure white, non-toxic, air-dry modeling material that's ideal for creating flow-ers, floral decorations, figurines and other sculptures. It dries in 24 hours and has a porcelain-like finish that can be further decorated with oil or acrylic based paints.

AMACO® CLAY FLOUR AND MOIST CLAY

A natural stoneware gray clay that fires to a light buff at Cones



5-10 (2185°-2381°F, 1196°-1305°C). AMACO® Clay Flour and AMACO® Moist Clay are natural, gray water based pottery clays. Exceptionally smooth, pliable, and suitable for hand modeling and throwing. They are not self-hardening clays.

AMACO® FLORAL CLAY

Arificial flowers and plants are secured in graceful arrangements and held firmly in containers with AMACO® Floral Clay. Fresh flower arrangements are tip-proof when the needle-point or other type of holders are adhered to containers with pliable AMACO® Floral Clay. This special formula clay is leaf green in color, never hardens and may be used over and over. AMACO® Floral Clay adheres to any surface and is non-tarnishing, Non-Toxic and will not harm silver.

ARTONE VENUS MODELING CLAY

Non-hardening. This superior quality plastic clay is specially recommended as a medium for professional sculptors. This responsive clay is Gray-Green in color, firm yet smooth. Additions of more clay will stick to the existing piece and can be easily smoothed or shaped. Modeled objects will neither crack nor sag and are unaffected by temperature and humidity. Artone Venus will not shrink and is perfect to make masters in order to cast plaster molds or build rubber latex molds. This clay contains sulfur, therefore it is not recommended to be used with (RTV) rubber molds.

INDUSTRIAL STYLING CLAY HBX-2

AMACO® HBX-2 is an industrial styling clay for designing large



and small models. It is a medium firmness clay that can be carved, extruded, shellacked, or painted. For large models a kneading type mixer equipped with a heating jacket is required. If such a mixer is equipped with an extruder it makes it easier to retrieve the clay as it comes out of the mixer.

Procedure: Set the mixer to a low heat, then place the clay in it and let it mix. The heat from the mixer and friction produced will heat up the clay. The clay temperature should be about 90°F-100°F while in the mixer. Do not heat the clay above 120°F at any time. For small projects heat the clay in a kitchen oven to 90°F-100°F. Do not heat the clay above 120°F at any time.

Once the clay has softened in the mixer or oven, take out or extrude the quantity that you would like to work with, and spread it with the palm of your hand onto the model by pushing the clay against the model, away from you. Base models are made out of wood or styro-foam. For small projects there is no need for a base model or armature. HBX-2 is a self-supporting clay which can be used by itself when making small projects.

Let the clay sit until it is firm again, then using a hard metal scraper, slowly scrape the surface until you have achieved your desired form. Additions to the form are possible by following the same steps of application and sculpting, mentioned above.

A minimum of a two inch layer of clay over a large base model is

recommended, however a thicker layer is also possible. This clay may be used indefinitely.

This clay contains sulfur, therefore it is not recommended to be used with (RTV) rubber molds.

EASY SQUEEZY™ CLAY

This soft, brightly colored clay is non-hardening, non-toxic, available in neon and bright colors, and great for small children. Easy Squeezy™ clay is so soft right out of the package that kids can begin playing immediately. Children will learn how to express themselves using their hands while having fun making their favorite characters and animals.

Easy Squeezy™ Clay is non-sticky, odorless, color fast and non-staining. It is available in chalk-sized sticks or larger blocks for use by children of any age.



SUPER DOUGH™ MODELING COMPOUND

AMACO® Super Dough™ Modeling Compound is a special plastic composition of harmless, colorful

ingredients. It is not a clay. The smooth, soft, pliable modeling compound is clean and greaseless. It will not stain or stick to hands, furniture or clothing. Colors may be blended and Super Dough™ Modeling Compound can be used over and over if protected from air in its own attractive plastic container. When exposed to air it will dry hard. Lids show color of contents.

AMACO® SCULPTAMOLD®

Sculptamold® combines the best feature of clay, plaster, and papier maché while eliminating the disadvantages. In dry form, this white, Non-Toxic compound is quickly prepared by adding water. Shake closed bag to thoroughly mix product before using, as some settling may occur in shipping. Sculptamold® sets in 30 minutes. Therefore, mix only enough Sculptamold® to finish modeling within this time. It will cling to almost all clean surfaces and does not shrink so it may be applied to an armature or any core without fear of cracking. By adding more water to your mixture, Sculptamold® may be press-molded or cast in sand, rubber or plastic molds. Surfaces may be decorated with any paint, tempera, acrylic, or Rub 'n Buff®. Although Sculptamold® is not waterproof, finished pieces may be made water resistant by coating with AMACO® Antique Bronze Finishing Glaze. Finished pieces are very lightweight, strong, and durable. May be carved, sanded, or sawed.

CLAYCRETE® — Instant Paper Maché

Pure white and dries white. It is easy to prepare, easy to model, very economical and exceptionally white when dried at room temperature. Finished projects are very lightweight. Furnished in dry form, it mixes with water and is ready to



use immediately. Claycrete® will start to set up in about 30 minutes, at which time fine modeling and smoothing of the surface is easily achieved. Additions of more Claycrete® are possible at any time during the modeling process. Mix only as much as can be used in 1/2 hour of modeling time.

Claycrete® will not stick to your hands or tools, making it exceptionally easy to work with.

Claycrete® dries best slowly at room temperature, however drying time could be shortened if dried in the sun or in an oven at 150°F (65°C). Claycrete® must be thoroughly dry before painting or decorating. It may be sanded, carved, or sawed.

CREA-STONE™

Crea-Stone™ is a lightweight, stone-like material in powder form that is mixed with water and cast into shapes planned for sculpture, plaques, and various art forms. When kept moist, it can be sculptured and carved with ease over long periods. When aged, Crea-Stone™ is stone-hard with a rough, granite-like texture, lighter than stone, permanent, and weather-proof. Simple implements or special tools may be used.

CASTING COMPOUND (Plaster of Paris)

When mixed with water and poured into a form,

AMACO® Casting Compound sets hard in a few minutes. Cast pieces and molds are white, fine textured and durable. See Pottery Plaster for Mixing instructions and ratios (Page 28).

MIX-A-MOLD™ — make a mold in minutes

Mix-a-Mold™ makes it easy to make perfect reproductions of three dimensional objects. Mix-a-Mold™ is fast and fun and picks up every detail. Supplied in powder form, it mixes with water and the mold is ready in two minutes. Fill the mold with casting compound, plaster or any other casting medium. Make copies from one original mold. Mix-a-Mold™ is Non-Toxic when wet.

Casting of hands, or a baby hand and foot prints can be made with

Mix-a-Mold™. Follow instruction on the box, however you can adjust the setting speed by increasing or decreasing the water ratio. To make a casting of your hand, take a gallon container, put one pound of Mix-a-Mold™ in it and fill 3/4 full of water, then mix very quickly. If lumps remain, do not worry. Put your hand into the mixture, wiggle it a little to let air bubbles escape then remain still until Mix-a-Mold™ changes from liquid to a gel.

Using a drinking straw, put it between your hand and Mix-a-Mold™ and blow air to detach it from your skin. Repeat this in several places around your hand until you feel your hand move freely. Pull out your hand very gently then pour plaster of paris or setstone in the mold. The mold will have to be cut in two to remove the plaster hand.

FLEXWAX

This versatile mold making material is simple to use—simply melt it then brush it on. Ideal for use with three dimensional objects, making face masks, casting hands, etc. Molds made with Flexwax can be remelted and used again and again.

Procedure For Making Simple Molds Using Flexwax:

1. Melt the Flexwax in a double

boiler. When it is completely melted, allow it to cool to a working temperature of 125°F (52°C).

2. Apply Vaseline sparingly over the surface of the object for easy release.

3. Brush the liquid Flexwax over the surface carefully.

4. After the entire surface is coated, cover with pieces of net reinforcing material such as cheesecloth.

5. Brush a second coat of Flexwax over the reinforcing material to the necessary thickness and allow it to cool.

6. For larger pieces, make a saddle mold using plaster bandage.

7. Remove the mold carefully and chill it by placing it in a tub of cold water.

8. Cast plaster, polyester or most any other material in the usual manner.

9. If you have used cheese cloth to reinforce the mold, carefully remove it from the wax when you remelt it.

AMACO® CARVING WAX

Make master sculptures for reproduction with this excellent carving medium. AMACO®





Carving Wax can be sculpted right from the block as supplied. For large size or different proportion original, melt one or more blocks in a double boiler. Carves easily with simple tools or utensils. Sculpt details and intricacies not possible with any other medium. Additions to the sculpture can be made by using the melted wax and adding it where needed. Finishes to an extremely smooth surface. Use the finished piece as a master to produce a mold in order to cast multiple copies of the same sculpture.

FRIENDLY PLASTIC® MODELING MATERIAL

Friendly Plastic® is a Non-Toxic plastic that can be used to create exciting jewelry, accessories, home decor, and wearable art projects. Finished pieces made from Friendly Plastic® can be used alone or combined with jewelry findings, picture frames, porcelain-like faces or anything available from your local craft store.

Free-form designs can be made with Friendly Plastic® softening in warm water (140°F, 60°C) and then shaping with your hands, craft tools, or other household object. Friendly Plastic® can also be used to create two-dimensional designs by layering different colors then carefully placing your design on a cookie sheet and baking in a standard or toaster oven at 275°F (135°C) for 2-3 minutes. Friendly Plastic® cools and becomes hard again in just a few seconds when placed into cold water, but can be resoftened for reuse or to make

changes when placed back into warm water. Friendly Plastic® Designer Sticks come in 74 metallic, primary, fashion, and florescent colors (see color chart in the AMACO® ceramic catalog or art and craft catalog).

Friendly Plastic® Pellets are white pellets, that soften in warm water (140°F, 60°C) for sculpting or pressing into a mold. No special tools are required. Friendly Plastic® Pellets are completely reusable. If you don't like the shape, simply resoften and start over.

FIMO® CLASSIC POLYMER CLAY

FIMO® Classic is a versatile, easy-to-handle polymer clay which hardens in your kitchen oven. It has particularly brilliant color intensity, is fade-proof and odorless. Unhardened FIMO® Classic, even soft-kneaded FIMO® Classic can be used again and again if well-packed and stored at normal room temperature. Any desired shade can be achieved by kneading more than one color together. White FIMO® Classic lightens the tone of individual colors. Larger models, or models with delicate projecting parts, should be supported from the inside with an armature.

Condition FIMO® Classic by holding it gently in your hand or setting it in a sunny location for a few minutes. You then can wedge it in your hand so that the heat from your hands will soften it and make it very pliable and easy to work with. **NOTE:** Excessive heat will damage the clay. After modeling, simply place the object in

a pre-heated kitchen oven set at 265°F (129°C) maximum (00 Translucent at 212°F, 100°C) for 30 minutes. Baked FIMO® Classic can be added to and baked again, providing it hasn't been varnished. Hardened FIMO® Classic can be carved, sawed, filed, cut, and painted; is watertight and washable.



FIMO® soft

All the qualities of FIMO® Classic only softer! FIMO® soft takes less time to condition than FIMO® Classic yet its consistency still has the firmness crafters have come to expect from FIMO®. Fimo® soft is available in bright colors and the softer formula also makes it easier for children to enjoy working with polymer clay.

PUPPEN (DOLL)— FIMO®

This polymer clay from the makers of FIMO® is specially designed for modeling dolls. Puppen (Doll) — FIMO® hardens in the oven just like ordinary FIMO®, but it is softer, which makes it easier to shape heads, arms, and legs. After hardening and cooling, smooth the surface with fine sandpaper then paint, varnish, or add accessories to complete your doll. Follow the same safety precautions as for FIMO® (previously mentioned). **NOTE:** FIMO®, FIMO® soft, and Puppen FIMO® are not toys. Supervise children during baking. Verify oven temperature with a cooking thermometer and do not

heat over 375°F (190°C) since it will cause decomposition of the product and release hydrogen chloride gas. Do not inhale fumes.

FIMO® MIX QUICK

A neutral mixing compound that's perfect for blending with crumbly or hard FIMO® to make kneading easier. When used in proper proportion (approximately one part Mix Quick to five parts FIMO®), colors will not change. Excellent for children.



LIQUID FIMO® DECORATING GEL

Now you can have all the advantages of regular FIMO® Classic and Soft in a liquid!

- Liquid FIMO® is transparent/translucent and can be used to make transfers from photographs, color photocopies, newspapers and magazines

- Tint with Genesis® Artist Colors from AMACO®, oil paints or dry pigments to create your own colors for painting onto wood and metal or onto unbaked polymer clay designs

- Liquid FIMO® is an excellent adhesion medium for connecting unbaked or baked polymer clay

Liquid FIMO® hardens in any home oven at 265°F in 15-20 minutes.

FRIENDLY METALLIC POWDER™

Perfect for use with FIMO® or other polymer clays, to highlight

or add an elegant richness to your designs. Brush on before baking or mix with Friendly Lacquer™ and apply after cooling to achieve the desired effect.

FRIENDLY LACQUER™

Use to protect, seal and enhance colors when crafting with FIMO® or other polymer clays, and Friendly Plastic®. Brush on after baking polymer clays for a matte or gloss finish. Brush over designs made with Friendly Plastic® to give them a shiny appearance. Non-Toxic, waterbase formula.

FIMO® METALLIC POWDERS

Apply with brush before heating or after cooling with FIMO® Lacquer to add a touch of sparkle to your creations.

FIMO® LACQUER

After cooling, items modeled with FIMO® can be coated with FIMO® Lacquer. Lacquer provides an additional protective coating and intensifies the brilliance of FIMO® colors.

LITHO-SKETCH®

Lithography is a printing technique which has evolved since the late 1700's when treated stone tablets were used to transfer images to paper. With Litho-Sketch® products, designs are created on paper masters and then reproduced.

1. Draw directly on the white side of the master — the back side is colored. Avoid fingerprints on the drawing surface. Since hands transmit some natural skin oils, unwanted fingerprints will show up in the final print.

2. Excellent drawing results can

be obtained with ordinary wax crayons. Fine line techniques can be executed with Litho-Sketch® Tusche. Litho-Sketch® Tusche should be allowed ample time to dry before desensitizing or printing.

3. Desensitizing your drawing with Litho-Sketch® Plate Solution prepares the master for accepting ink. Place plate, with drawing side up on an old newspaper to absorb any excess solution. The solution is applied to the master with a soft applicator, cotton pad or sponge. The applicator is dipped into the solution, the excess squeezed out and the entire master surface is moistened. The amount of the Plate Solution that is deposited on the drawing should be moderate. It is important to always work with



clean applicators and change them often to ensure that prints are clean. **IMPORTANT:** The master **MUST BE** moistened with Litho-Sketch® Plate Solution before each inking. **NOTE:** Excessive Plate Solution on the Litho-Sketch® Master can be transferred to your printing paper causing slight yellowing. Allow the Plate Solution to evaporate after inking the master and before printing.

4. Keep your master on the newspaper after desensitizing. It will keep the brayer from inking

your table surface. Litho-Sketch® Printing Ink is recommended because it is specifically prepared and formulated for precise print and for immediate use. It will take three or four proofs for the master to build up a full charge of ink, after that it will begin to ink up fully with a few passes of the brayer. For the smoothest ink application, roll on two inking slabs, which could be any non-absorbent surface (marble, glass or glazed tiles) use one slab to roll freshly squeezed ink and the other for evening the application on the brayer. The roller is correctly charged when there is a slight hissing or adhering sound as it is worked back and forth. In order to prevent emulsification (mixed ink

and solution) roll the brayer lightly over a paper towel prior to recharging it on the inking area.

5. After desensitizing and inking you are ready to print. The application of pressure transfers the ink from your master to the print paper. Litho-Sketch® inks will print on most papers, however letter quality papers are most effective. Carefully place a clean sheet of paper over the inked master. The paper should be slightly larger than the master. While holding the paper in place with one hand, rub the back of the paper with a flat wooden spoon.

Rub back and forth along the entire paper surface, then reverse and rub on the opposite side. Before removing the print paper from the plate, raise one corner to check that ink has been adequately transferred. If not, replace carefully and continue rubbing until the desired effect is achieved. Effective printing results are achieved more quickly and easily by using a press or wringer type roller.

NOTE: The number of prints you will receive from one master will depend on the materials used in the drawing and how detailed it is. You can expect approximately 10-30 prints from each master. For multiple color reproduction, each color requires a separate master. Registration is very important when using multiple masters. One easy registration method is to use a two or three hole paper punch to punch the master and the printing paper. By using Carlson 250 x 110 pins which fit into two holes, it will automatically align the masters and the print paper on top of the master. This is aligned by taping the pins to the board with duct tape. The pins will then align all colors drawing side up and printing paper print side down.

6. Clean up. Much of the ink on the brayer can be removed by rolling it in the newspaper. Using mineral spirits on fresh cotton pads, wipe away any excess ink on the brayer. Repeat this process to remove ink from your inking slab.

IMPORTANT: When working with children **DO NOT USE MINERAL SPIRITS**. Use only special hand soap. Just lather the hand soap, place it on the cotton pads and wipe the ink from the brayer and slab. Or use Brush Flush® from the AMACO® ceramic catalog. More detailed information about Litho-Sketch® is found in an eight-page brochure which can be requested from AMACO®.



RUB 'N BUFF®

Rub 'n Buff® is a decorating, antiquing and finishing medium that produces a UNIQUE finish. Rub 'n Buff® can be applied on any clean, dry surface such as wood, glass, plastic, plaster, fabric, metal, ceramics, paper, leather, and over other painted surfaces. Rub 'n Buff® has a durable, lasting finish with a lustrous sheen.

To apply, squeeze the tube gently to bring finish to the tube opening. Stroke fingertip over opening to pick up a very small amount of finish. Rub it evenly and thinly over smooth surface or raised designs. A soft cloth pad or dry, firm, short-bristle brush may be substituted for fingertip. Use a gentle, rubbing motion rather than strokes. Rub 'n Buff® dries instantly—buff with soft cloth or facial tissue to full beauty. Buffing a single color finish will intensify the metallic tones of the high surfaces in contrast to the deeper tones of the low relief areas. When using Rub 'n Buff® as a base coat on a rough or large area, where the fingertip won't penetrate, use either a dry-brush application

or use a brush slightly dampened with solvent (mineral spirits or turpentine). Use a paper towel to blot excess solvent from brush before stroking it across the finish in the tube opening. Then apply as you would paint. When dry, buff. Fingertip highlighting may be applied at once if desired.

Rub 'n Buff® colors can be intermixed to achieve a desired shade or color that is not available.

Because Rub 'n Buff® dries so fast and the finish colors may be used over or under each other, more than one highlighting color is often used. Gentle buffing of each color, with a soft cloth will reveal a lasting, lustrous finish of "hand rubbed" appearance. Surfaces which will have unusually hard wear should be protected with a suitable, workable spray, like Krylon, which you can buy from a hardware store or brush on AMACO® Antique Bronze Finishing Glaze.

BRUSH 'N LEAF® (INTERIOR)

Brush 'n Leaf® Interior metallic finishes go on easily with one appli-

cation. Just brush it on almost any clean surface. Brush 'n Leaf® formula features metallic flakes that dry quickly to a durable finish. Decorate picture frames, lamps, and craft projects like ceramics.

When using ceramic bisque, it is recommended to first seal the bisque with an acrylic paint. A beautiful and simple project to do, would be as follows.

Take a sculptural ceramic bisque piece or plaster of your choice. Paint a brown or red acrylic paint all over the piece. Pour some Brush 'n Leaf® on a glazed ceramic tile or a piece of glass. Using a sponge dip into the Brush 'n Leaf® and pounce over the whole sculpture. The brown acrylic underneath will give the gold a rich antique look. Let dry thoroughly. Then, dilute the brown acrylic stain with water and apply all over the gold. Next, before it dries out, take a soft rag and wipe the stain off the high surfaces, leaving it in the indentations. If too much is left then you can apply Brush 'n Leaf® where it is needed by pouncing it on with the sponge.

BRUSH 'N LEAF® (EXTERIOR)

Brush 'n Leaf® is a rich semi-matte metallic paint that will not dull or tarnish in winter weather or summer sun for a full two years or more. Just brush on Brush 'n Leaf® and the exclusive outdoor formula does the rest. Brush 'n Leaf® works wonders on almost any clean, dry, outdoor surface to decorate lamp-posts, lawn furniture, house numbers ... anything on or around your home that is exposed to the weather. Brush 'n Leaf® is the one-step outdoor metallic paint that works on metal, plastic, wood, stone, stucco, and concrete. Naturally, it works well indoors too! Brush 'n Leaf® exterior is recommended to be applied over sealed surfaces.

ANTIQUE BRONZE STENCILING

With precut stencils, latex or acrylic base coats, Rub 'n Buff® Metallic Wax, and water based varnishes, bronzing is fun and easy.

Rub 'n Buff® is a wax base metallic finish in a tube which sets

up in about 30 minutes. It is a decorating, antiquing and finishing medium which is a formulation of imported carnaube waxes, fine metallic powders, and selected pigments. It produces a unique finish that no paint can duplicate.

Just follow these easy steps:

1. Select a surface and prepare it by sanding, scaling and base coating in your selected color. Use a good quality acrylic latex basecoat, apply it smoothly and allow adequate drying time. Basecoat a piece of tagboard or cardboard in the same color to practice.

2. Practice the stencil and the technique. These practice pieces can be taped in place to determine placement and intensity of color.

3. Place the stencil in the appropriate place and tape to the surface with drafting tape.

4. Place a small amount of Rub 'n Buff® Metallic Wax on a palette. Hold brush as a pencil with bristles flat on surface and handle straight.

NOTE: Bristles of the stencil brush are cut specifically for this action. Pick up a small amount of Rub 'n Buff® and work into the brush with a circular motion, making sure it is evenly distributed. Work the bristles into a paper towel to remove any excess. You must build color slowly, placing the metallic wax on layer by layer. This enables you to create wonderful shading variations.

5. With brush in upright position,

start on outside edge of cutouts with very light pressure, working in a circular motion towards the center. A light coat overall begins the procedure, then additional highlighting can be done on top of original coat (i.e. the center of a piece of fruit would have a strong highlight, while the outside edge dropped away to the background). Reverse the circular motion to add additional color. Contrasting colors can be used to highlight or shade.

6. Lift the corner of the stencil to check intensity of color before removing stencil completely.

7. If using more than one color, use a stencil shield to cover the adjacent areas while you paint.

8. When stenciling is complete, allow a setting time of approximately one hour.

9. If stray bits of Rub 'n Buff® appear outside the stenciled area, remove with a pencil eraser, then wipe surface with a tack rag.

10. Using a good varnish brush and AMACO® Antique Bronze Finishing Glaze or Stencil Ease Stencil Cote, apply several coats, allowing adequate drying time between coats.

Clean-Up: Clean stencil with paper towel which has been dampened with an odorless brush cleaner, such as Brush Flush® available from AMACO®.

Brushes can also be cleaned with Brush Flush®.

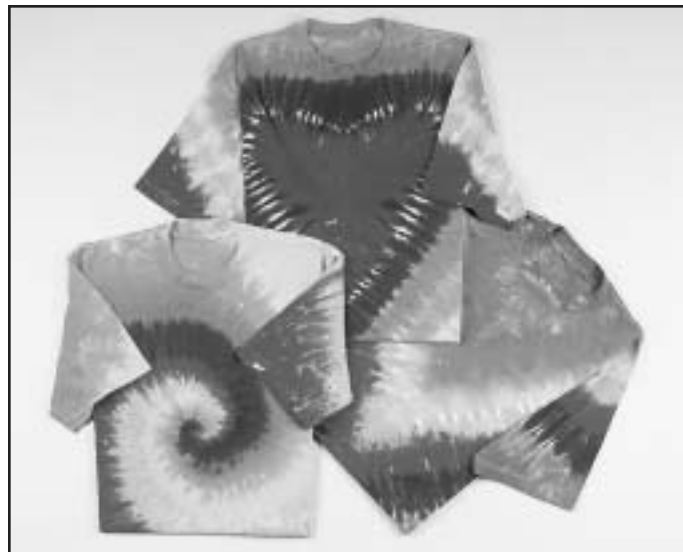

BATIKIT®
 Instructions for
 Dyeing One Pound
 of Cloth or Yarn
 with Batikit®
 Coldwater Dyes

Place cloth to be dyed in a container such as a sink, plastic or metallic bucket, or washing machine (if cycles can be controlled). Add enough cold water to cover cloth and allow free movement (not more than 1½-2 gallons). Ideal water temperature is 100°F, 38°C. Remove cloth, wring out and set aside. Add dye (1-3 teaspoons) to one cup warm water. Stir until completely dissolved, add to dye bath and stir. Now add cloth and stir. Allow to soak ten minutes. Now add 1½ cups salt; ½ cup at five minute intervals. After all salt is added, soak twenty minutes (remember to stir every five minutes).

Completely dissolve three table-spoons of washing soda or soda ash in one cup hot water and add to dye bath, while stirring. Stir five minutes, allow to soak one hour, stirring every five minutes.

IMPORTANT: Washing soda makes the dye react and become permanent, otherwise all dye will wash out.

Washing soda is not necessary when dyeing paper.

Remove cloth and rinse in cold water. Wash in hot, soapy water and rinse. A lot of excess dye will wash out. When the rinse water runs clear, all dye remaining in the cloth is absolutely permanent and it is safe to wash your dyed cloth with other clothes in the wash. Bleach and enzyme products will remove some colors.

NOTE: Equally permanent, but less intense colors can be obtained in half the dyeing time by reducing recommended times in each step by half.

To dye more than one pound, multiply the recommended amounts of dye, salt, washing soda and water by the number of pounds to be dyed. Recommended times remain the same. **STIR AT LEAST EVERY FIVE MINUTES THROUGHOUT DYEING.** If cloth is soiled or sized, wash it first to get an even color.

Silk Screening,
 Painting or Printing
 on Fabric

Screen printing inks and paints cannot compare to the individually, hand-made designs achieved with BATIKIT® Dyes mixed with BATIKIT® Dye Thickener. Even on the finest silk cloth, you will feel no difference between the screened



and unscreened areas of the fabric. The process requires mixing the "Thickener" and dye and washing the fabric after printing. Very fine lines and permanent colors are produced on all natural fibers: cotton, linen, viscose rayon, and silk, also, with less effectiveness on wool.

Add dye powder to BATIKIT® "Thickener", a mixture of sodium alginate and urea, to obtain a smooth print paste. Details on amounts to use are included in "Thickener" instructions. When screen printing, use a 12XX screen that is not water soluble (use 10XX when a lot of dye must go through the screen, such as printing on terry cloth). "Thickener" is available from your local supplier or direct from American Art Clay Co., Inc.

After screening, painting, or block printing, the colors are set with heat by ironing, steaming, or baking. If cloth is to be worn or exposed to moisture, a final wash in cold water and hot, soapy water is required to remove excess dye and chemicals. Clean up with soap and water.

Recommended only for jobs which require the finest results.

Wool Dyeing Instructions (1 lb. Cloth or Yarn)

Silk may be dyed by either this hot water method or the cold water process described in cloth and yarn instructions. **STIR AT LEAST EVERY FIVE MINUTES THROUGHOUT DYEING.** If cloth is soiled, wash first in warm, soapy water to insure an even color (Do not use detergent).

NOTE: Wool dyeing instructions are very similar to the cold water process except: dyeing is done on the stove at simmering temperature and three cups of vinegar are used in place of three tablespoons washing soda (per one pound cloth). Also, there is very little wash off as

wool accepts the dye extremely well.

Place material to be dyed in a large metal pan that can be heated on the stove. Add enough warm water to cover cloth and allow free movement (not more than 1½-2 gallons). Remove cloth, wring out, and set aside. Add dye (1-3 teaspoons) to one cup warm water. Stir until completely dissolved, add to dye bath and stir. Now add cloth and stir. Place pan on stove and set at medium heat or low flame. Allow to soak ten minutes. Now add 1½ cups salt, ½ cup at five minute intervals. After all salt is added, soak twenty minutes (remember to stir every five minutes). Adjust heat to bring water to simmering temperature (do not boil). Add three cups household vinegar, while stirring. Stir five minutes. Allow to soak one hour, stirring every five minutes.

IMPORTANT: Vinegar makes the dye react and become permanent when dyeing wool. Keep temperature at simmering. **DO NOT BOIL.**

Turn off burner heat and allow dye bath to cool slowly for ½ hour, or until water temperature is warm. Remove cloth or yarn and rinse well in warm water. Wash in warm, soapy water (use soap flakes) and rinse.

Tie-Dyed Tee Shirts

1. Wash garment or fabric before you dye it. This step removes sizing and the fabric will react better to the dye. Remove excess water by running through spin cycle of washing machine if necessary. A damp shirt is easier to manipulate into knots, pleats, etc.

2. For best results use 100% cotton fabric (any natural fiber is okay). Fabric containing polyester is not recommended.

3. Colors may appear darker in the dye bath than when they are dried.

4. Be very careful when removing bands or ties from the project as it is easy to accidentally snip the fabric. When using tee-shirts, the fabric could "run" and ruin your shirt.

5. We do not recommend putting dyed articles in the dryer to speed the process. The tumbling action of the dryer causes dyed areas to rub against each other which could ruin the design.

Directions: (It Is Important to Wear Gloves While Tie Dyeing)

1. Mix one package of fixer in hot water to form a paste, then add mixture to two quarts of hot water.

2. Rinse article in the fixer and wring out.

3. Let article sit for 5-10 minutes to set the dye and make it permanent.

4. Lay shirt out flat and put string down the center. Fold shirt in half over string.

5. Place another piece of string in center of folded shirt and fold half over string. Your shirt will be folded in quarters.

6. Arrange shirt into a U-shape. Pull the strings until fabric is in tight ball. Tie ends of string together.

7. Place rubber bands around center of the fabric ball.

8. Mix one package Batikit® dye with a small amount cold water. Then stir into one quart of cold water. For lighter colors add more water. For brighter colors use less water.

9. For one-color dyeing, immerse the ball into the dye bath. For two-color dyeing, immerse each half of ball into different colors. Squeeze out excess dye from ball. Place in plastic bag for 24 hours.

10. Rinse with cold water until water runs clear. Wash with a detergent and rinse until water is clear.

NAIL HOLE AND CORNER FILLER

Apliable filler for crevices and nail holes, Nail Hole and Corner Filler is especially useful with picture frames. It will not shrink, harden, or dry, therefore care should be taken not to place frames on furniture, fabric, or carpeting. Nail Hole and Corner Filler may stain these surfaces.

Do not use AMACO® Nail Hole and Corner Filler in nail holes in the walls because it will not harden.

New shades of colors can be achieved by mixing two or more colors together.



TROUBLE SHOOTING GUIDE — AMACO® GLAZES AND UNDERGLAZES

UNDERGLAZES (LUG, VELVETS, VELVET-1-STROKES, DESIGNER VELVETS)

Bleeding: This defect is due to a heavy application of clear glaze, especially if applied without a pre-bisque firing of the underglaze.

* This problem cannot be corrected once it has been fired. Next time make sure to fire the designed piece to a mature Cone 04 (1940°F, 1060°C) then apply the clear glaze thinner and fire to the maturing temperature of the glaze.

Milky Look: This appearance is the result of underfiring or a heavy clear glaze application.

* Refire at a higher temperature. Next time apply the clear glaze thinner. In most cases two coats of clear glaze is usually sufficient.

Milkiness could also be due to devitrification over certain colors of underglazes.

* Refire at a higher temperature. Next time apply underglaze design to greenware, bisque fire to a mature Cone 04 (1940°F, 1060°C) bisque. Then apply a thinner coat of clear glaze. Two coats is sufficient.

Peeling, Chipping, or Shivering: Can be caused by the following—(a) Too heavy an application of underglaze (b) Dust or grease on the surface of the ware (c) Incompatibility of the clay body with the glaze.

* For best results apply underglaze on greenware then bisque fire to a mature Cone 04 (1940°F, 1060°C). Whether on greenware or bisque, always apply thin coats of underglaze, waiting between coats for the wet sheen to disappear before applying the next thin coat, etc. Do not apply underglazes heavily at one time. Clean greenware with a moist sponge to eliminate dust before starting your decoration.

Uneven Color Application: Before glazing, it is possible to hold the fired, underglazed object under running tap water. The water will act as a magnifier and expose any color variation. Correction can be made with additional application of underglaze followed by refiring and then glazing.

Firing Out: Can be caused by improper application, particularly of light colors and/or overfiring. Although most AMACO® underglazes will fire at high temperature, it is always advisable to check the temperature color variation chart in the decorating colors section of the AMACO® catalog as to the recommended temperature of each color.

Black Specks (Sun Strokes underglazes): Specks may occur if the colors or the clear glaze is applied too heavily, or if the bisque has not been matured to a Cone 04 (1940°F, 1060°C).

Color Burn Out (Sun Strokes Underglazes): To avoid color burn out (a) Fast fire Sun Strokes (b) Do not over fire (c) Apply only on bisque ware (d) Do not fire greenware with Sun Strokes.

GLAZE PROBLEMS

Pinholes: Pinholes are a common occurrence and can be caused by many different factors. (a) When the glaze is applied over greenware, rather than bisque (b) Pinholes will also occur when the glaze is applied over immature bisque (c) When the glaze is underfired (d) When using a slip body right after agitation when air is still trapped in the slip; use slip that has been aged (e) Using clay with coarse particles or an excessive amount of organic material; the large holes left in such a clay body cannot be covered in the glaze firing (f) Wet coat over wet coat of glaze without permitting glaze to dry between coats may cause pinholing.

* Correction can be made by reglazing and refiring to the recommended temperature.

Cratering and Bubbling: Will occur (a) If glaze was applied over an immature Cone 04 (1940°F, 1060°C) bisque (b) If glaze application is too thick (c) If glaze firing is too fast especially when using lead free glazes (d) Cratering can also occur because of underfiring and sometimes because of overfiring.

* To correct the problem, grind the blisters carefully without cutting yourself. Apply one coat of the same glaze and refire slowly at the recommended temperature. For new pieces follow label instruction of the glaze.

Crazing: Crazing can occur due to the following reasons: (a) The bisque was not fired to a mature Cone 04 (1940°F, 1060°C) (b) Glaze application is too thick, especially if firing too fast (c) The kiln was cooled rapidly (d) Clay and glaze are incompatible.

* To correct, fire at a higher temperature. However for best result, make sure bisque is fired to a mature Cone 04 (1940°F, 1060°C). Glaze application should be moderate, especially if using lead free glazes. Fire to the correct temperature of the glaze.

Crawling: Can occur due to: (a) Too thick an application of glaze (b) The presence of a hard spot on cast bodies (c) Dust or grease are present on the bisque (d) Force drying certain glazes (e) Thick old glaze applied as is or if only water is added to thin it.

* Make sure to work on good bisque, use a wet sponge and wipe dust off your bisque. If using old thick glaze, add a small amount of water and AMACO® Gum Solution before using. Correction of a defected piece can be made by reglazing and firing to the correct temperature of the glaze.

Milky or Cloudy Glaze: This appearance indicates that the ware was: (a) Underfired or application of the glaze was too thick (b) Ware is too close to an open peep hole or too close to the wall of the kiln where there are no elements.

* Correction is sometimes possible by refiring to the right temperature of the glaze.

Grainy and Rough Surface: May be caused by one of the following: (a) There is a deficiency of glaze on the ware.

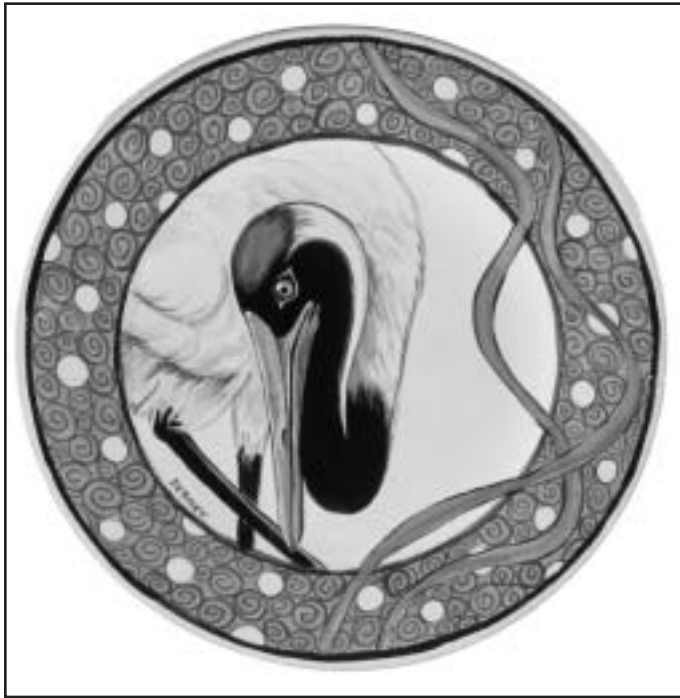

* To correct, simply reheat the ware and then reglaze and refire.

(b) The glaze that was applied is underfired. This may be because the kiln has shut off early for some reason and thus underfired, or a high fire Cone 5 (2185°F, 1196°C) glaze was applied by mistake instead of a low fire Cone 05 (1915°F, 1046°C) glaze.

* To correct, verify the kiln, check the elements, or if you have applied a high fire Cone 5 (2185°F, 1196°C) glaze. Try to reglaze with a low fire glaze and refire to Cone 05 (1915°F, 1046°C), the result may not be what you wanted, but you will be able to save the piece. If you still want to use a Cone 5 (2185°F, 1196°C) glaze, make sure you are using it over a stoneware or porcelain body; otherwise the low fire ware will melt if high fired to Cone 5 (2185°F, 1196°C).

(c) Too much water added to dry glaze causing it to settle. Applying a glaze that has settled or not properly mixed may result in a grainy and rough surface because not all ingredients are picked up by the brush in such a case

* To correct, make sure you have followed the mixing instructions for the dry glaze making sure it is a creamy consistency before re-applying.

Black Specks and Gray Discoloration of Cadmium Reds and Orange Glazes (i.e. LG-53, 56 and 66): An indication of contamination. It is recommended that the kiln walls, shelves and floor be kept dust free. Vacuum the kiln regularly to clean off glaze particles and foreign matter. Specks may also occur in red and orange glazes when they are fired with other colors or with greenware in the same kiln. Red and Orange need to be fired in a clean kiln with an abundant amount of oxygen. Therefore, do not over-stack the kiln, leave plenty of room between the pieces and fire fast. Refer to directions on pages 15 and 19.

Gray or discolored Red and Orange will occur if there is insufficient application of glaze, if the firing was too slow, or if the ware was overfired.

* To correct, heat the piece, then apply at least two coats of glaze, letting it dry completely between coats. You can reheat it again or use a hair dryer to dry

it during application and between coats. Refire fast to Cone 06 (1830°F, 999°C) or lower.

Excessive Flowing: May occur mostly in leaded art glazes like some of the LT Series glazes or the L Series glazes. It can be caused by too heavy an application of the glaze in combination with a fast firing.

* To correct in such instances if you tend to glaze heavy, then apply only two coats and make sure not to overfire.

Glossy Appearance of Matt Glazes: Will occur if these glazes were overfired or if the firing was too fast.

* To correct, apply one coat of glaze and refire slowly to recommended temperature.

Failure of a Crackle Glaze to Crackle: Will occur if the glaze was overfired, or if application of the glaze was too thin.

* To correct, apply a thin coat if you think it was a thin application otherwise just refire to the recommended temperature.

Splitting of Ware: Can occur when using slip cast ware, where the ware is thin, and glazed with Crackle glaze on the outside after the interior of the ware has been glazed and fired with a non-crackle glaze. It is recommended to glaze the non-crackle interior and the crackle exterior and fire at the same time.

SP PEBBLE—POSSIBLE PROBLEMS

Flaking Off: Sometimes occurs while Pebble is drying.

* To prevent this, we recommended applying one coat of AMACO® Gum Solution or Wax Resist before firing. To achieve an even all over pattern in a large area, apply Pebble with a fan brush and with a criss cross application for even dispersion.

OIL BASE VERSA COLORS—OB SERIES

Pinholes and Crawling: Pinholes and crawling in the Versa Color can be caused by: (a) Dust on the ware or grease from handling

* To correct clean the prefired glazed piece with alcohol before applying the Versa Color.

(b) The prefired glaze surface is not perfect. Any defects on the glazed piece will show in the Versa Color when it is fired

(c) Dust on the decal paper if you are doing decals

* To correct wipe the paper clean with a soft lintfree cloth.

Blisters: Blisters are caused by: (a) Too thick an application and by overfiring.

* To correct, sand down the rough area, apply another coat, and refire to the right temperature.

(b) Firing too fast

* To correct, fire in four hours from start to maturing temperature.

Reds and Pinks: Reds and Pinks will fire out when fired too slow or applied too thin. Apply a reasonable thickness and fast fire in three hours or less from start to maturing temperature.

Decals: Blisters are caused by a thick application of Versa Color

* To correct apply decals thin. Put pressure on the squeegee when silk

screening. When silk screening, use the color as it comes in the tube, do not thin before silk screening.

Cloudy Decals: Cloudy decals are caused by too thick an application of Decal Magic (covercoat)

* To correct apply covercoat moderately—too thin an application of covercoat will tear the decal when applying it.

WATER BASE VERSA COLOR—WB SERIES

Pinholes: Pinholes are caused by an imperfect glaze surface on which they are painted. Make sure the ware to be decorated is fired to its maturing temperature, and is free of pinholes or other defects.

* Usually this problem is hard to correct. Two or three applications of the same color with firing in between sometimes corrects the problem.

Uneven Color: Water base Versa Color have to be applied in thin coats with firings in between coats. Two or three coats is best. Make sure brush application is even.

Reds and Pinks: Reds and Pinks are dark. This is caused when underfired.

* To correct, apply one coat and refire to the right temperature. Read specific directions on how to fire WB Versa Color (page 27).

Pink is brown, Red is black when overfired.

* To correct apply one or two coats and refire according to instructions (page 27).



WATER BASE VERSA COLOR—OPALESCENT

Glossy and Smooth Appearance: Caused by overfiring. Opalescents must be fired to Cone 017 (1385°F, 752°C) for the best results.

* To correct, apply one coat and refire to the right temperature. If it is not corrected, repeat one application and refire.

APPENDIX I — THE ART & CREATIVE MATERIALS INSTITUTE, INC.

The Art & Creative Materials Institute, Inc. began in 1936 as the Crayon, Water Color & Craft Institute, Inc., a non-profit association of manufacturers of children's art materials. Since its beginning, the purpose of the Institute has been to establish high quality product standards and to be of service to industry, school, and the public. In 1939 the Institute initiated its Certified Products Bureau to provide assurance to educators, parents and doctors that its members' products were safe. Since 1940, formulas submitted to the Institute have been evaluated by an independent toxicologist and the labeling has been nationally recognized by the

Poison Control Centers.

Several years ago the Institute changed its name in order to encompass all art material manufacturers and provide a standard for all types of art materials. The AP seal which originally designated the quality of materials has come to mean much more as the Institute became the driving force behind testing and health labeling of all art materials. The Institute's standards for safety and quality have become the national standard.

AP: "Products bearing the AP Approved Product Seal of The Art and Creative Materials, Institute, Inc. are certified in a program of toxicological evaluation by a medical



expert to contain no materials in sufficient quantities to be toxic or injurious to humans or to cause acute or chronic health problems. This program is reviewed by the Institute's Toxicological Advisory Board. These products are certified by the Institute to be labeled in accordance with voluntary chronic hazard labeling standard ASTM D-4236. In addition, there is no physical hazard as defined within 29 CFR Part 1910.1200 (c)."

CL: "Products bearing the CL Health Label (Cautions Required) Seal of the Art and Creative Materials Institute, Inc. are certified to be properly labeled in a program of toxicological evaluation by a medical expert.



This program is reviewed by the Institute's Toxicological Advisory Board. These products are certified by the Institute to be labeled in accordance with the voluntary chronic hazard labeling standards ASTM D-4236."

For more information on the history and the role of the Institute in art materials safety, write The Art and Creative Materials Institute, Inc. 715 Boylston St., Boston, MA 02116 or call (617) 426-6400.

Visit our AMACO®
web site for the latest
safety information:
www.amaco.com

APPENDIX II — AMERICAN SOCIETY FOR TESTING AND MATERIALS (ASTM)

ASTM was founded in 1899 and is a private, non-profit organization for developing and publishing voluntary standards for industry.

ASTM D-4236 is the Standard Practice for Labeling Art Materials for Chronic Health Hazards. This practice is under the jurisdiction of

ASTM Committee D-1 on Paint and Related Coatings and Materials and is the direct responsibility of Subcommittee D-01.57 on Artist Paints and Related Materials.

ASTM C-1023 is the Standard Practice for Labeling Ceramic Art Materials for Chronic Adverse Health Hazards. This practice is

under the jurisdiction of ASTM Committee C-21 on Ceramic Whitewares and Related Products and is the Direct responsibility of Subcommittee C-21.08 on Standards of Ceramic Materials for Artists and Hobbyists.

These standards are subject to revision at any time by the responsible

technical committee. They must be reviewed every five years and if not revised, either reapproved or withdrawn. You may write ASTM directly for a complete copy of the above standards or for more information on the Society itself. Please write to ASTM Committee on Standards, 1916 Race Street, Philadelphia, PA 19103.

APPENDIX III — MAJOR HEALTH HAZARDS

When excessive amounts of **cadmium** are inhaled, lung damage may occur. Excessive absorption may result in kidney damage, damage to the testes or risk to the developing fetus. Excessive **lead** absorption may result in damage to the ner-

vous system with weakness and difficulty in thinking, kidney damage, anemia, difficulty with child bearing or risk to the developing fetus. Cancer agent based on experimental data. Excessive absorption of **cobalt** may cause damage to the heart and lungs. Excessive exposure to **copper**

may cause anemia. Excessive inhalation of **quartz dust** may result in chronic lung damage. Cancer agent by inhalation based on laboratory tests. Health risks from the use of glazes, slips and clays are minimized through good personal hygiene, good housekeeping practices and the

use of a NIOSH-approved dust mask when mixing clays or slips. Pregnant women or women considering pregnancy who are active ceramists should notify their physician of their work with ceramic products and avoid all products containing lead and cadmium.

APPENDIX IV — FEDERAL LABELING LAW OF ART MATERIALS

On November 19, 1988, the Federal Hazardous Substances Act was amended and enacted by the Senate and the House of Representatives to require the labeling of **chronically hazardous** art materials. Labeling is to conform to ASTM D-4236

intended for users of any age. Compliance with this law was to go into effect two years after its enactment which was November 18, 1990.

Even before this new law was enacted, American Art Clay Company, Inc. had been labeling in conformance with ASTM D-4236, based on reviews of formulations by

an independent toxicologist, through the Art and Creative Materials Institute. Also in conformance with this new law, our formulations are reviewed periodically and labeling changes are made based on new available data to the toxicologist.

Although this is a federal law, we

recommend users and suppliers of Art and Craft Materials to check their own state laws which may differ and act accordingly. Some states such as Massachusetts may have more severe restrictions as well as penalties against non-complying sellers of Art and Craft materials.

APPENDIX V — QUICK REFERENCE LIST OF ALL AMACO® GLAZES AND UNDERGLAZES

A. Lead Free

Federal Law — Approved for use in Grades K-6 and Above

Massachusetts Law — Approved for use in Grades K-6 and Above

AMACO® LG Series: 1[®], 10[®], 11[®], 14[®], 20[®], 21[®], 23[®], 24[®], 30[®], 34[®], 40[®], 42[®], 44[®], 48[®], 50[®], 51[®], 52[®], 54[®], 55[®], 60[®], 61[®], 62[®], 65[®], 760[®]

AMACO® F Series: 1[®], 10[®], 11[®], 15[®], 20[®], 21[®], 22[®], 23[®], 25[®], 30[®], 31[®], 40[®], 41[®], 42[®], 43[®], 50[®], 51[®], 52[®], 53[®], 54[®], 55[®], 56[®], 57[®], 58[®], 60[®], 61[®], 65[®], 66[®]

AMACO® CTL Series: 1[®], 3[®], 9[®], 10[®], 11[®], 12[®], 13[®], 15[®], 31[®], 32[®], 36[®], 41[®], 42[®], 43[®], 61[®], 65[®]

AMACO® LM Series: 1[®], 10[®], 11[®], 15[®], 16[®], 20[®], 25[®], 30[®], 32[®], 42[®], 46[®], 50[®], 52[®], 53[®], 54[®], 55[®], 56[®], 57[®], 58[®], 60[®], 65[®], 66[®], 202[®], 230[®], 231[®], 244[®]

AMACO® LT Series: 13[®], 15[®], 17, 30, 32, 34, 113, 132[®], 147[®], 161[®], 166[®]

AMACO® HF Series: 1[®], 9[®], 10[®], 11[®], 12[®], 13[®], 14[®], 17[®], 18[®], 21[®], 22[®], 23[®], 24[®], 30[®], 31[®], 32[®], 36[®], 37[®], 41[®], 50[®], 51[®], 52[®], 53[®], 54[®], 55[®], 56[®], 57[®], 58[®], 60[®], 62[®], 63[®]

AMACO® CR Series: 10, 11, 15, 30, 31, 41, 42, 50, 51, 53, 60

AMACO® ST Series: 20, 30, 33, 40, 51, 53, 55, 56, 65

AMACO® DG Series: 1[®], 11[®], 15[®], 20[®], 21[®], 23[®], 26[®], 27[®], 30[®], 40[®], 41[®], 42[®], 50[®], 51[®], 52[®], 53[®], 54[®], 55[®], 56[®], 57[®], 58[®], 59[®], 62[®]

AMACO® TH Series: 1[®], 2[®] (High Fire Texturizers)

AMACO® TL Series: 1 (Low Fire Texturizer)

AMACO® O Series: 10[®], 11[®], 12[®], 30[®], 42[®], 52[®], 54[®], 57[®], 60[®]

AMACO® SE Series*: 701[®], 702[®], 710[®], 730[®], 731[®], 732[®], 740[®], 760[®]

AMACO® LUG Series*: 1[®], 10[®], 15[®], 20[®], 21[®], 22[®], 25[®], 26[®], 30[®], 31[®], 40[®], 41[®], 42[®], 43[®], 50[®], 51[®], 52[®], 53[®], 54[®], 55[®], 56[®], 60[®], 61[®], 65[®]

AMACO® GDC Series: 1, 10, 15, 20, 25, 27, 28, 30, 31, 40, 41, 42, 50, 51, 52, 53, 54, 56, 57, 58, 59, 60, 62, 65

AMACO® Semi-Moist Underglaze Tube Set # 408: Maroon, Light Yellow, Blue-Green, Dark Blue, Dark Green, Light Brown, Black, White, **Set # 409:** Medium Blue, Turquoise, Lilac, Pink, Warm Gray, Mahogany Brown, Bright Yellow, Irish Green, **Set # 410:**

Purple, Light Blue, Aqua, Rose, Orange, Peach, Chartreuse, Suntan, **Set # 411:** Amethyst, Hunter Green, Light Red, Real Orange, Red, Salmon, Violet, Electric Blue

AMACO® Semi-Moist Underglaze Pan Set # 108: Maroon, Light Yellow, Blue-Green, Dark Blue, Light Brown, Black, White, Dark Green,

Set # 109: Turquoise, Medium Blue, Lilac, Pink, Warm Gray, Mahogany Brown, Bright Yellow, Irish Green, **AMACO® Semi-Moist Underglaze Pan Set # 110:** Purple, Light Blue, Aqua, Rose, Orange, Peach, Chartreuse, Suntan, **Set # 111:** Amethyst, Hunter Green, Light Red, Real Orange, Red, Salmon, Violet, Electric Blue

AMACO® Underglaze Pencils: Black, Brown, Green, Rose, Yellow

AMACO® Underglaze Crayons Set #208: Turquoise, Yellow, Rose, Brown, Dark Green, Black, White, **Set #209:** Lilac, Yellow-Green, Gray, Medium Green, Light Brown, Blue-Green, Dark Brown, Medium Blue

AMACO® V Series*: 301[®], 302[®], 303[®], 304[®], 308[®], 309[®], 310[®], 313[®], 314[®], 315[®], 316[®], 317[®], 318[®], 320[®], 321[®], 322[®], 323[®], 325[®], 326[®], 327[®], 328[®], 332[®], 333[®], 334[®], 336[®], 341[®], 343[®], 345[®], 350[®], 353[®], 354[®], 355[®], 356[®], 357[®], 360[®], 361[®], 366[®], 367[®], 368[®], 369[®], 370[®], 371[®], 380[®], 381[®], 382[®], 383[®], 384[®], 385[®]

AMACO® GDC Series: 1[®], 10[®], 15[®], 20[®], 25[®], 27[®], 28[®], 30[®], 31[®], 40[®], 41[®], 42[®], 50[®], 51[®], 52[®], 53[®], 54[®], 56[®], 57[®], 58[®], 59[®], 60[®], 62[®], 65[®]

AMACO® Arroya Series: White, Black, Brown

AMACO® CR Series: 250, 260

AMACO® UT Series: 1001, 1002, 1003, 1004, 1005, 1006, 1007, 1008, 1009, 1010, 1011, 1012, 1013, 1014, 1015, 1016

AMACO® DV Series*: 3302[®], 3308[®], 3316[®], 3320[®], 3325[®], 3327[®], 3328[®], 3334[®], 3354[®], 3360[®], 3367[®], 3368[®], 3369[®], 3371[®], 3372[®], 3374[®]

AMACO® Water Base Versa Color: 3, 12, 27, 36, 48, 56, 62, 66

AMACO® Water Base Opalescent Versa Color: Amethyst, Emerald, Turquoise, Ruby, Silver, Pewter, Copper, Gold

AMACO® SP Series: Snowfluff, Mender, Overdrift, SP-400

AMACO® V-1-S Series*: 1308[®], 1309[®], 1313[®], 1314[®], 1317[®], 1322[®], 1326[®], 1336[®], 1345[®], 1353[®], 1360[®], 1370[®]

AMACO® Semi-Moist Overglaze Pan Set # 508: Red, Red-Brown, **# 509:** Yellow-Green

B. Lead Free — These products contain ingredients other than lead which require the CL seal along with specific directions for their safe use.

Federal Law — Approved for use in Grades 7 and Above

Massachusetts Law — Approved for use in Grades 7 and Above

AMACO® LG Series: 2[®], 25[®], 26[®], 27[®], 45[®], 46[®]

AMACO® LT Series: 3[®], 12[®], 16[®], 22[®], 48

AMACO® F Series: 26[®], 27[®]

AMACO® O Series: 2[®], 20[®], 21[®], 23[®], 26[®]

AMACO® HF Series: 26[®]

AMACO® CR Series: 26

AMACO® ST Series: 23, 25, 42

AMACO® DG Series: 25[®]

AMACO® CTL Series: 20[®], 22[®], 26[®], 34[®], 35[®],

AMACO® SE Series: 720[®]

AMACO® Semi-Moist Pan Set #108: Dark Blue, Black

AMACO® Semi-Moist Pan Set #109: Medium Blue

AMACO® Underglaze Chalk Crayons: Dark Blue

AMACO® Underglaze Pencils: Blue

C. Lead Bearing — These products require the CL seal along with specific directions for their safe use.

Federal Law — Approved for use in Grades 7 and Above

Massachusetts Law — Approved for use by individuals Age 19 and Above. (Not suitable for schools, nursing homes, etc.)

AMACO® LG Series: 9[®], 32[®], 36[®], 53, 56, 66

AMACO® LT Series: 24, 31, 115, 121, 122, 130, 133, 142, 144

AMACO® CTL Series: 33, 50[®], 54[®]

AMACO® SP Series: 10[®]

AMACO® Semi-Moist Overglaze Pan Set# 508: Yellow, Blue, Green, Black, White, Orange

AMACO® Semi-Moist Overglaze Pan Set # 509: Peach, Turquoise, Violet, Gray, Pink, Chocolate Brown, Special Blue

AMACO® Oil Base Versa Color: 1, 12, 22, 32, 46, 54, 60, 64

AMACO® Glass and Metal Enameling Colors: Red, Pink, White, Yellow, Blue, Green, Black, Turquoise

AMACO® SS Series: 201[®], 202[®], 203[®], 204[®], 205[®], 206[®]

AMACO® L Series: 511, 512, 514, 516, 518[®]

AMACO® Fine Art Glazes: SP-510, SP-2001

* AMACO® LUG, SE, V, V-1-S, and DV Series Underglazes have only been tested and approved as dinnerware safe when applied and fired under AMACO® LG-10 Clear Glaze. Other glazes may also be used. Tableware producers must test all finished ware through a certified laboratory to establish dinnerware status due to possible variations in firing temperature and contamination.

CONCLUSION

We hope that the information provided in this booklet will enable teachers, students, parents, administrators and potters to understand that by using AMACO® products, whose quality

you can trust, ceramics can be just as safe as it is exciting. To again quote Monona Rossol, "Ceramics will persist as a vital art and craft because people will continue to be intrigued, as they have for thousands of years, with the mystery,

majesty and enjoyment of turning plain clay and minerals from the earth into strong, permanent objects...I know that with care, thought and planning, ceramics can be created without harm to me or my students." (Ceramic Scope,

October, 1980, p.6)

The American Art Clay Co., Inc. offers you both the safe products and the complete information necessary to provide a safe ceramic environment. We urge you to use both.

NOTES

NOTES



AMACO[®]
American Art
Clay Co., Inc.
Indianapolis,
Indiana 46222

www.amaco.com

(317) 244-6871
www.genesisartistcolors.com

Fax: (317) 248-9300
www.brentwheels.com

(800) 374-1600
www.genesisdecorativeart.com